



Hss Ltd. is a leading Israeli manufacturer, integrator and supplier of intelligence and security solutions. Established in 1999, the company provides advance solutions for intelligence, investigations and security professionals.

Company's Aim

The company's aim is to provide professional sophisticated, state of the art high technology solutions in the field of intelligence, investigations and field equipment for governmental and non-governmental professional users.

Products and Services

The company provides off-the –shelf products made by the best manufacturers in the world and custom-made solutions that are tailored especially for the specific needs of the customer.

Showroom and Training Center

The company is operating a special showroom and training center in the center of Tel-Aviv in which customers can come in to see, learn and try its state of the art products and solutions.

Successful Track Record

HSS's professional staff has developed products and solutions, which were used successfully in real enemy territories in many places in the world. The company was founded and is headed by former officers of the Israeli Police Elite investigation unit.

Customer Base

HSS Ltd. serves Governments, Ministry of Defense, Army, Police, Intelligence Agencies, Air Forces, Special Forces, Special law Enforcement Agencies, Multi national Corporations, Financial Institutes, Academic Institutes and others.

Quality Assurance

HSS Ltd. is certified to ISO-9001:2000

Expertise

HSS Ltd. unique range of products and solutions include: High Resolution Miniature Video Recorders, World Smallest HR Cameras, COFDM miniature Encrypted video Transmitters, Professional Audio transmitters and loggers, Cellular Encryption solutions, IED and Cellular Jammers, VIP Protection Systems, Crisis Management Systems, GPS/GPRS Professional Location Systems, Tactical Surveillance Counter Measures equipment, Miniature Audio/Video Eavesdropping equipment and more...

Unique Services

HSS Ltd. unique services include: Technical Consulting for Special Projects, Project Management and Implementation, Professional Eavesdropping Devices Search Team, Technical Training, Special Installations and more....



HSS-RC20 - Covert Key Chain Video Recorder DVR

Totally Covert! Looks Like Common Key C

World's Smallest High Grade DVR core with Micro SD Card Slot. Built-in High Resolution Camera That Takes Both Video And Still Shots. Photo Quality 1280 X 1024 Resolution. Built-In High Grade Rechargeable Battery. Simple And Fast USB Connection. One Button Recording Or High Resolution Snap Shot. Covert **Vibration Feature** Lets You Know You Got Your Video Evidence. 3 Hours Video Recording Time And 3 Hours battery Life

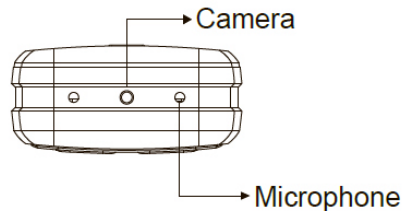

Specifications:

<i>Built-In Camera</i>	<i>CMOS Camera</i>
<i>Angle of View</i>	<i>61 Degree</i>
<i>Recording Resolution</i>	<i>640x480@29fps</i>
<i>Memory Type</i>	<i>Micro SD Card (2GB)</i>
<i>Max. Picture Elements</i>	<i>1,300,000 pixels</i>
<i>Video File Format</i>	<i>Standard MPEG-4 (AVI)</i>
<i>Audio File Format</i>	<i>WMA</i>
<i>Pictur File Format</i>	<i>JPEG</i>
<i>PC Interface</i>	<i>Mini USB2.0</i>
<i>Consumption Current</i>	<i>Stand By : 120 mA / Recording : 150mA</i>
<i>Date/Time Table</i>	<i>YYYY/MM/DD, HH,MM,SS</i>
<i>Vibration Alert</i>	<i>On/ Off/ Record/ Photo</i>
<i>Power Supply</i>	<i>DC 5V/ 2A</i>
<i>Battery Charging Current</i>	<i>250 mA</i>
<i>Battery Type</i>	<i>DC 3.7V/550 mA Li-on Battery</i>
<i>Battery Lifetime</i>	<i>190 Minutes</i>
<i>Dimension</i>	<i>71x35x16 mm</i>
<i>Weight</i>	<i>34 g</i>

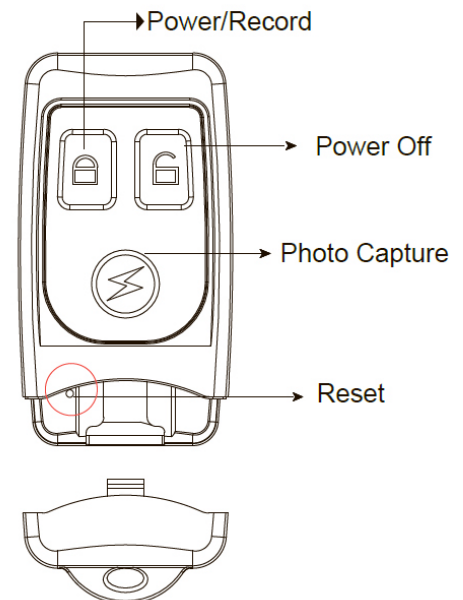



HSS-900 Invisible Secrets Video System

This is high-end covert body wear innovation at it's best!

The HSS 901 Invisible Secrets DVR is a law enforcement grade DVR built into a cell phone that has motion activation and time and data stamping. The high grade, high-resolution low light hidden CCD camera is built into the top of the cell phone.

Press a secret function key once you turn the covert video system on for recording and the screen of the cell phone looks like a normal cell phone. No one but you knows that it is recording video.



Display at Spy Mode



Display at regular mode

The HSS 901 Invisible Secrets DVR can also be used as a standard pocket DVR to plug external cameras into it and record high-resolution video powering the cameras of your selection.

DVR Specifications:

- DVR Built Into Cell Phone Completely Covert And Invisible
- Resolution: 720 X 480 @ 18 fps / 640 X 480 @ 30 fps
- Memory: 16 GB micro SC Card
- up to 16 hours recording time
- 2 X 1.5 TFT LCD High Resolution Screen
- 3 screen modes for cover operation
- Time And Date Stamping
- DC 5V rechargeable battery
- Power To External Cameras



CAMERA

Built In Camera Specifications:

- 450 Lines of Resolution Color CCD
- 4.3 mm lens, 80 degree angle of view, 0.2 Lux
- Shutter Speed 1/60-1/120,000
- Power Source-Self-powered by Unit.

Belt Clip allowing camera to operate



Standard accessories

- Specially Designed Belt Clip Holder That Lets Camera Point Out
- Battery Charger Cord, Earphone Jacks, USB connection Cord, RCA Jacks



HSS-800 & HSS-800RX High Resolution Ultra Advanced Pocket DVR!

Powers Cameras • 30 GB Hard Drive • High Resolution • Time/Date Stamping • Motion Activated Mode • SD Card Slot For More Memory! • Up To 80 Hours Recording Time! • Hide In Plain Sight Belt Carry Case! • Tamper-Proof Watermarking Of Each Frame!

Super high resolution:

Able to record 720 x 480 super high resolution quality picture into 30 GB hard drive built In. SD memory card slot for up to 4 GB Memory.

Output power supply: features output power plug to offer power to various covert cameras



True Time And Date Stamping! • High capacity battery: • Motion Activated Option • Small Pocket Size • One touch record button • Easy playback using IR remote control

Specifications

Display: 2.4 TFT LCD- (2 3/4 X 2 inch screen)

Video input: NTSC/PAL standard

Video recording: MPEG-4

Resolution: 720 x 480 pixels at 25 to 30fps

Memory type: 30 GB HDD, Up To 80 Hours!

Audio and Photo recording: yes

Dual A/V Input: Both 2.5 & 3.5mm AV Input Jack

Audio/video out: RCA 3-in-1 AV output

PC interface: USD2.0

Camera power supply: DC 5V/500mA

Power supply: DC 5V

Operation current: 650mA

Battery: Removable 3.7V/1.8 amp Lithium Battery

Battery lifetime: 70 minutes (including external CCD power)

Dimensions: 5 inches long X 3 inches wide X 3/4th of an inch deep!

Weight: 263/313g with/out battery

HSS-800RX – includes a built in wireless AV receiver 1.2 & 2.4 Ghz for receiving, watching and recording wireless cameras



HSS-800RX

HSS-800

Standard accessories

Remote controller • Removable Lithium Battery • USB and AV lead cable • Camera connector cable • Belt clip carrying case • Earphone

Optional Accessories

Wired and wireless remote control



HSS-700 & HSS-700RX High Resolution Ultra Advanced Miniature DVR!

GIVES YOU A "BODYWEAR" COVERT VIDEO SYSTEM AT IT'S BEST!

Powers Cameras • SD card slot • High Resolution • Time/Date Stamping • Motion Activated Mode • Up To 2 Hours Battery time with powering camera • Hide In Plain Sight Belt Carry Case! • Tamper-Proof Watermarking Of Each Frame!

The HSS-700 is a new generation high-resolution high-end pocket digital video recorder that is law enforcement grade. The HSS-700 can be turned into a high-grade wireless pocket digital video recorder HSS-700RX.

Super high resolution:

Able to record at 720 x 480 super high-resolution quality picture. SD memory card slot for up to 4 GB Memory. Output power supply: features output power plug to offer power to various covert cameras



HSS-700

True Time And Date Stamping! • High capacity battery: • Motion Activated Option • Small Pocket Size • One touch record button • Easy playback using IR remote control

Specifications

Display: 2.4 TFT LCD- (2 3/4 X 2 inch screen)
Video input: NTSC/PAL standard
Video recording: MPEG-4
Resolution: 720 x 480 pixels at 18 640X480 25fps
Memory type: SD, Up To 4GB
Audio and Photo recording: yes
Dual A/V Input: Both 2.5 & 3.5mm AV Input Jack
Audio/video out: RCA 3-in-1 AV output
PC interface: USD2.0
Camera power supply: DC 5V/500mA or 12V/500mA
Power supply: DC 5V, current: 650mA
Battery: Removable 3.7V/1.8 amp Lithium Battery
Battery lifetime: 60 minutes (including external CCD power)
Dimensions: 95 X 55 X 25 mm
Weight: 263/313g with/out battery



HSS-700RX

HSS-700RX – includes a built in wireless AV receiver 1.2 & 2.4 Ghz for receiving, watching and recording wireless cameras

Standard accessories

Remote controller • Removable Lithium Battery • USB and AV lead cable • Camera connector cable • Belt clip carrying case • Earphone

Optional Accessories

Wired and wireless remote control



Hi- Resolution 550TVL Hidden Cameras Especially Designed for HSS-700/800/900 Video Recorders

This is a plug & go solution for our advanced digital video recorders. Plug into the recorder the 2.5mm PL connector and the camera is connected to the video recorder. The video recorder supplies power to the camera while the Audio Video signal from the camera is recorded on the device with this one small connector.

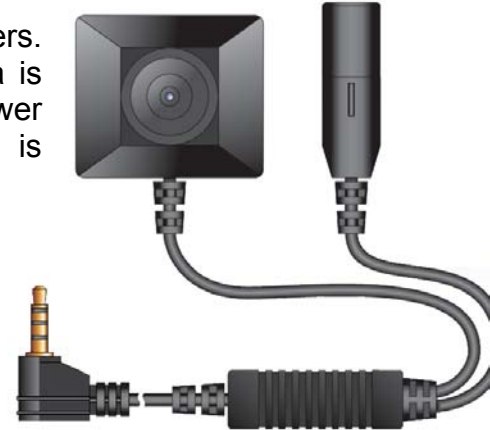

Specifications:

Video System	NTSC & PAL
CCD Image Sensor	Interline 1/3 inch SONY SUPER HAD CCD
Picture Element	NTCS: (H)768x(V)494 ; PAL: (H)752x582
Resolution (H)	550 TV Lines
S/N Ratio	More than 45 dB (AGC off)
MIN Illumination	0.2 Lux / 30 IRE @ F2.0
Electronic Shutter	NTSC: 1/60~1/100,000; PAL: 1/50~1/100,000
A.G.C	+18dB MAX
Video Output	1.0V p-p Composite at 75 ohm
Audio Output	2Vp-p(MAX) 10KHz ohms Impedance
MIC Sensitivity	Yes
Lens	4.3 mm
Angle of View	78 Degree
Power Supply Voltage	5V+/-0.5V
Power Supply Current	220 mA
Dimension (Incl Lens)	25(W)x25(H)x18(T) mm
Weight	22 g



Book Type



Earphone Type



Tie Type



Cap Type



Podium Mic. Type



Pin hall Type



Hand Bag Type



Button / Screw Type



Brooch Type



Tactical Helmet Type Camera Designed for HSS-700 & HSS-800

One button to Turn ON and START recording

This way you record only what you need and save memory space and battery time

Wired waterproof remote control

Allowing you to control the DVR without taking it out of its pouch

Detachable camera

User can replace the camera according to his needs like using super low light camera or powerful zoom camera etc.

Ergonomic head mount for long time wearing

Specially designed for professional users for long time wear in high humidity and heat climate

Designed to work with HSS700 & HSS-800

Especially designed to work with our high quality DVR's. The DVR powers the camera and the camera remote control controls the DVR.



Applications:

- Traffic or Patrol Police – recording day-to-day activity
- SWAT Teams – recording during the attack or special mission
- Door Guard or Body Guard – recording the scene during the urgent condition
- Education – recording of training for review and training
- Outdoor Activity – recording any kind of sport or other outdoor activity.

Camera Specifications:

- 450 Lines of Resolution Color CCD
- Number of pixel – 768X582 (PAL)
- S/N Ratio – 48db (min)
- 4.3 mm lens, Angle of view 80 degree
- 80 degree angle of view
- 0.2 Lux low light rating!
- Shutter Speed 1/60-1/120,000
- Power Source- 5-12 VDC or self-powered by DVRs
- Current – 250mA
- Mic sensitivity: -50dB, +/- 3dB
- Weight 30g





REAL TIME GPS / GPRS TRACKING SYSTEM

The system is based on SIRF III GPS module that insures amazing real-time accuracy. There is no need to enter the coordinates by hand; the mobile pc software provides visual route and location of the monitored object VIA regular GPRS communication.



Software solution

The solution we offer is basically the software engine working behind the units. Even if you already have your own GPS GPRS devises we can connect them to our state of the art software solution and to offer you more options such as:

Complete discretion – as we do not offer service as we offer the system your information will be at your position. No one will be able to know what and when you track

- Mobility – you can track the units on the go by your standard mobile phone or PDA.
- Geo-fence – you will be notified when the unit is entering or exiting a specific location.
- Control - you will be notified when the unit's speed, distance or brake time is over the limits you set.

Two models are available:

- Miniature autonomic personal unit for monitoring humans, animals, merchandise etc.
- Tactic waterproof magnetic unit with long battery lifetime and moving sensor.



The system is aimed for both civil / law enforcement applications and can be modified to the customer specific needs.

System architecture:

The system transmits its location received by its built in GPS module, by the cellular network to the Internet. The customer's server, which is connected to the Internet, receives the location and put it on the map. The server allows mobile devise such as PDA's or mobiles phones to connect to the server and retrieves the unit's location and maps. This way it is possible to track the location of the unit even if you are not in the office in from of the PC. You can see the location of the unit on your standard mobile phone





Total Protection System

Built to provide you with state of the art solution for Temporary VIP & Premises Total Protection

Features:

- Wireless Alarm System with up to 64 different detectors with 8 zones
- Wireless PANIC Buttons – up to 5 different wireless panic buttons with indication on main unit and on beepers carried by the guards.
- Both visual and sound indicators for Alarm and panic – sound can be turned off.
- Professional 4 channel DVR with D1 resolution recording and 500GB HDD. Built in DVD for events backup and fast download.
- Cellular Communication module - allowing independent connection to the Internet anywhere for remote view and control
- Easy SIM card switch slot for using local SIM card when traveling in the world.
- Built in wireless DECT switch with external cellular telephone line and 4 mobile handsets for local communication between the guards and the protected VIP.
- WI-FI capability for establishing local wireless network for remote view on site by using palm PC or WIFI cell phone.
- 4 wireless IP-67 video channels with the option to connect different type of cameras for different locations.
- Replaceable rechargeable batteries for the video links allow constant protection 24/7.
- Optional COFDM video link is possible for long range transmitting in urban environment.
- 10"4 LCD display for monitoring the cameras and playback recordings.
- Voice recording for wireless camera
- Voice recording for main unit surrounding – used especially for training and debriefing.
- Telephone conversation recording.
- Rigid Logistic suitcase for cameras, sensors, detectors and accessories for fast deployment and easy storage.





Remote Observation System

For professionals the usage of binoculars is no longer needed when observing or following up an object.

HSS mini size remote observation system is built to provide comfortable, powerful and professional solution for long time observations and follow up.



Features:

- Powerful Day Night, mini size Zoom camera with X36 optical magnification
- Optional optical multiplication to increase zoom up to X72 !!!
- High quality 7" LCD display suitable for day light use
- Independent mini size, 60GB. DVR with integral 3.5" LCD monitor allowing playing recording on the spot while live view is still active on the large screen.
- Optional Video Motion Detection with vibration alert option available. Suitable especially for long time observation on static objects.
- Optional Cellular communication module for real time video transmission to the dispatch anywhere in the world.
- The camera can be disguised in many non suspicious standards objects such as a rock or in the car
- The units is supplies with a special tripod allowing to fix the camera almost anywhere
- The whole system is delivered in a rigid plastic box for fax deployment and easy storage



VIP PROTECTION SYSTEM

Complete mobile high-end rigid security system for VIP protection, swat teams, intelligent units, army and police units etc'.

The system is designed for fast deployment in places where fixed security system is not an option.

The system combines CCTV monitoring, wireless alarm system and panic button into one system that allows the user total control in real-time.

The system supplied with logistic case for convenient transport and it is built for the move.



Wireless Alarm System:

- 3 units of wireless PIR detectors – for indoors use.
- 1 unit of wireless magnetic sensor – for doors / window

Once the detector is triggered the main unit will alerts by both Beep and Light indications that will show which area has been activated. SMS notification is optional.

Wireless PANIC Button System:

The system supplied with a panic button that transmit a stress signal to the main unit.

SMS notification is optional.

Wireless and Weird CCTV System

- 3 pcs. of wired hidden CCTV camera 1/3" CCD 2.8mm lens. Supplied with 20m cables.
- 1 unit of wireless hidden CCTV Camera with internal battery for 10h, 1/3" CCD 2.8mm lens hidden camera.
- 10.4" LCD TFT adjustable screen.
- 4 Channels 100fps DVR,(digital video recorder) 500GB HDD.
- T.V out – to connect the unit to a bigger screen.



AMBUSH SYSTEM



System info:

Professional video recording system based on 4 channels DVR with 250GB HD. The system is completely sealed, rigid and designed to be berried under ground.

To the system connected up to 4 stone covert professional B/W camera for night view at minimum illumination of **0.0003 LUX!** – Optional IR illuminators for 0 LUX conditions.

The system records continually or once it detect motion,(VMD), generation 2 of the product offers SMS alerts and remote unit control.

The system supplied with internal 10h battery or more then 1 week with external power case.

The system offers WiFi abilities to view the cameras in real-time mode or downloading selected record to a laptop computer.

Optional outdoor PIR detectors / tramping stripe to alert via SMS / trigger the system.

Each system is custom made to the specific surrounding of the working areas and can be changed to the unique demands of each customer

Premises Control & Protection System

The PCS-15 Is a rigid portable wireless CCTV combined with outdoor PIR detectors that provides secure sterile zone for remote protecting of pre-define area.

The system insures nothing is entering the secure zone from ground level by silent or loud alerting on a remote control rigid suitcase. This remote unit is equipped with a rigid DVR computer connected to a 10.4" LCD screen for cameras real time view and record. The system is equipped with X 36 zoom day / night PTZ controlled camera for 360° inspection, optional add up to 6 cameras at total.

The control unit is capable of working with a GPRS PCMCIA / USB modem for remote sight full control.

The system has self-protraction detectors to insure reliable on going reliable operation.

System parts:

Transmission side:

1. Wireless 15m detection PIR detectors for 2 edges control – 2 units.
2. PTZ controlled camera with a 3m tripod and a directional antenna.
3. Main unit rigid suitcase combined with power supply.
4. Self guard detectors to insure no one is tempering the detectors or main unit.
5. loud speaker

Receiver side:

1. Rigid Remote Control Unit: 6 CH DVR, 10.4" LCD screen, PTZ control, alarm system with LED zone indicators. Optional GPRS Tx.
2. Directional antenna on a 3m tripod.

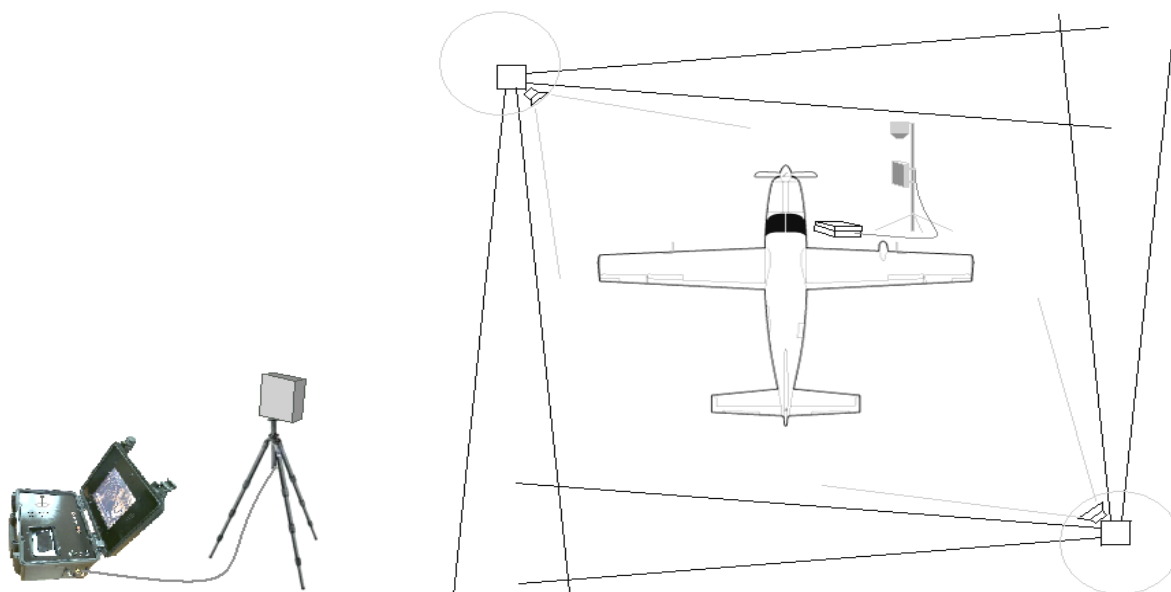



Powerful Hand Held Hidden Surveillance System

Professional powerful hidden surveillance camera hidden in a hand held bag for long-range documentation under hushes surrounding.

The system includes a high quality CCD camera with adjustable electronic optical zoom up to X 36 for full-face recognition even at low light conditions and long distance. A hidden mini box connected directly to the camera provides covert, easy and simple operation. Mini size DVR and high power batteries are installed also in the bag allowing a full solution.



Aiming to the target from long distance its not easy but with this system does not require any specialty. Inside the bag there is a hidden low power Video Transmitter that transmits the video to a hand held wireless Video receiver with a 1.8" LCD screen that looks like a cell-phone. The operator can "look at his phone" and aim the camera to the right position.

The RF transmitter inside the bag can be switched on / off at any time by a hidden switch.

- Best quality MPEG-2 video recorder is used to provide approx. 2Hrs of continues recording time.
- High quality MPEG-4 Video recorder is used to provide more then 4Hrs. of continues recording time.

The system is custom made and can be modified according to the user special needs.

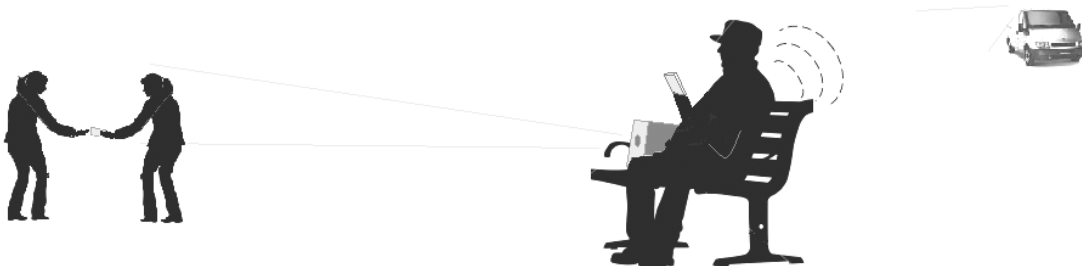

Optional upgrades:

- COFDM Digital / Analog video transmitter for real time surveillance
Remote viewing over TCP/IP



MULTI PURPOSE RIGID, FAST DEPLOYMENT WIRED or WIRELESS CCTV SYSTEM

Outdoors fast deployment rigid CCTV. The system is built for harsh surroundings operation and mobility. With a rigid case and high-end waterproof camera connectors the system insures multi functional outdoors abilities. The system is based on a shockproof mobile DVR to insure stable continues record, the system supplied with two removable 320GB HDD for on the spot swap.

A build in high-resolution 7" or 10.4" TFT LCD display enables the user to adjust camera position and to view recorded data, it is possible to connect the system via a video out connection to any external screen.

The DVR is controlled by a IR remote control for easy intuitive operation for non technical users.



It is possible to integrate WIFI or 3G wireless connectivity for remote viewing and controlling.

This product is manufactured according to the customer's specifications and needs. We can add, change or improve any component according to your needs



Concealed Carry-On Audio Video Surveillance Systems

We offer wide range of concealed Carry On Audio Video Systems based on the customer specifications and requirements. Our systems are innocent to the outside viewer and allow the user to walk freely even into places where standard security check is required.

We use large variety of high quality video recorders. In some cases we will use flash memory based DVR that allow to user to run, jump or do any other activity which shock the DVR. Or in other cased we will use miniature palm size DVR with 160GB HDD, which allows the user to record video for more then 4 weeks constantly.

We offer sophisticated solutions based on more then one camera in a bag with automatic camera change according to the bag position – one camera is for vertical video recording and one for horizontal recording. According to the bag position the Mercury switch will change cameras.

For the audio solution we use high quality high gain microphones. We can also combine more then two microphones and allow the user to use the bag as a remote listening devise. For this we use a sophisticated audio mixer that is concealed as well inside the bag.



This product is manufactured according to the customer's specifications and needs. We can add, change or improve any component according to your needs



HSS-R100 Remote Controlled Observation System

The New HSS remote controlled Observation system was developed to fulfill a tactical need raised from special involvement units. Unlike any other system, in the new HSS-R100 the whole electronics parts including the COFDM video transmitter, the Telemetry receiver and the camera are cased together in aluminum case to meet IP-67 standards.

Main characteristic of the system

- SONY CCD Day/Night camera Optical Zoom X36.
- Built in COFDM Video Transmitter output power 500mW – effective range in urban surrounding 500-800 meters.
- Optional external 10W COFDM video transmitter with effective range of 1000-1500 meters in urban surroundings.
- Telemetry control unit based on 5W telemetry transmitter with effective range of 1500 meters in an urban surroundings.
- Digital video recording –based on H264 digital video recorder in Full D1, 25 FPS audio/video



The remote control panel offers easy to use and intuitive operation option for the non-professional user. To the professional user it offers remote control on all cameras options and menus so the user can control and adjust the picture for his special needs.

This system was developed according the the needs of a customer, therefore if it does not fit as is to your needs we will be able to modify and change it so you will have a system fits completely to your special requirements.





HSS-VW500 – SEARCH CAM

The HSS-VW500 is our new and advanced solution for searching in hidden places, built to work in rough environments even in direct sunlight.

Designed especially for the Israeli Police special bomb search and disassemble unit it solved a critical need for the professional forces in the field.

This system is built of three main components: Camera with integral LED light, LCD Display, Recording unit, Batteries,



The Search Camera Specification

- **LED Light**
- 1/4" Color CCD
- 640x480(N/P)
- 380 TV Lines
- 0.3 Lux
- (D)9.1 x 38 (mm)
- 4.0mm/F2.0



DVR Specifications:

VIDEO/ RECORDING	
Compression Format	H.264
Recording Resolution	4CIF (NTSC: 704X480, PAL: 704X576)
	2CIF (NTSC: 704X240, PAL: 704X288)
	CIF (NTSC: 352X240, PAL: 352X288)
Recording Quality(High)	4CIF:1500Kbps, 2CIF:1200Kbps, CIF:1000Kbps
Recording Frmate Rate	PAL: 25, 12, 8, 6, 5, 1 fps
	NTSC: 30, 15, 10, 6, 3, 1 fps
Recording Mode	Emergency / Schedule / Alarm / Motion Detection
Storage	Support SD, SDHC (8GB max.)
Maximum Recording File	2,000 files /Storage Device





Wireless Hidden Cameras

HSS-20 High Resolution Cellular Type Wireless CCD Camera

Designed for covert video surveillance use. You can be very close to your target and appear to be minding your own business talking on a cell phone but you are really taking high quality and high-resolution covert video footage!

Specifications/Special Features:

Original Ericsson most popular model • 1/4-inch Panasonic DSP Color CCD • 480 TV lines 43,000 pixels, 1.0Lux, F1.2 • Built-in 4.3mm pinhole lens 80-degree • vibration alert under low-battery • PLL circuitry embedded



Specifications:

- Frequency: 2410,2430,2450,2470;1080,1120,1160MHz
- Output power: 100mW and 150mW
- Trans range: 30 to 100 meters and 100 to 200 meters
- Mic sensitivity: -50dB, +/- 3dB
- AC power supply: 100 to 120 AC to 4.9V DC/450mA
- DC power supply: 3.6 DC/770mA Li-on battery
- Bat charged time: 1.5 hours
- Battery life time: 50 minutes, 1.5 hours
- Power consumption: 700mA +/-10%, 570mA +/-10
- Weight: 53g (include battery)
- Dimensions: 100 x 47 x 22mm

HSS-10 Covert Calculator Wireless CCD Video Camera

This high-grade wireless full color covert video camera built into a working Casio calculator features a high grade 1/4 SONY DSP Color CCD sensor video camera built right into it to obtain that vital covert video footage!

Features And Specifications:

- High Grade 1/4 Sony DSP Color CCD Wireless Camera
- Functioning Calculator
- 480 TV Lines, 32,000 Pixels
- 1.0 Lux F 1.2
- Built In 4.3 mm pinhole lens 78 Degree
- Auto Electronic Shutter (AES) And Auto White Balance
- Phase Lock Loop Circuitry Embedded
- Three Channel Adjustment
- Mic Sensitivity 60 dbm
- AC power adaptor Or battery
- Weight: 250g (With Battery)
- FCC Approved





Wireless Hidden Cameras

HSS-12 Hi-Res. Cigarette Pack Type Wireless CCD Camera

Actual cigarette pack with hidden color 380 SONY CCD camera and transmitter. 100m "line of sight" range. Camera looks out the lower right side of pack (at UPC code) A single 9-volt battery operates camera/transmitter for 8 hours. To turn unit on, simply open the top and push the red button. A green LED confirms the unit is operating. Camera/Transmitter module can be easily removed to replace battery or insert into a new cigarette pack. Kit includes cigarette pack camera, hard carry case, receiver, AC adaptor for receiver, 9 volt battery, and 12 hour "AA" battery Pak for receiver.

- High Grade 1/4 Sony DSP Color CCD Wireless Camera
- 480 TV Lines, 32,000 Pixels
- 1.0 Lux F 1.2
- Built In 4.3 mm pinhole lens 78 Degree
- Auto Electronic ZShutter (AES) And Auto White Balance
- Phase Lock Loop Circuitry Embedded
- Three Channel Adjustment
- Mic Sensitivity 60 dbm
- AC power adaptor Or battery powered
- Weight: 250g (With Battery)



HSS-18 Covert Soft Drink Can Wireless CCD Video Camera

This high-grade wireless full color covert video camera built into a soft drink can features a high grade 1/4 SONY DSP Color CCD sensor video camera built covert video footage!

Features And Specifications:

- High Grade 1/4 Sony DSP Color CCD Wireless Camera
- Functioning Calculator
- 520 TV Lines, 32,000 Pixels
- 0.1 Lux F 1.2
- Built In 4.3 mm pinhole lens 78 Degree
- Auto Electronic Shutter (AES) And Auto White Balance
- Phase Lock Loop Circuitry Embedded
- Three Channel Adjustment
- Mic Sensitivity 60 dbm
- battery time – 4-10Hrs.
- Weight: 350g (With Battery)



Removable button of
the Soda can



COFDM Digital Video Transmitter Ultra Small, High Power

The HB6100 video link is based on a digital transmission modulation called COFDM. The COFDM technique allows sending data on multiple carriers, while using digital constellations as QPSK and QAM.

This kind of modulation allows large bit rates with the ability to send enough data and coding to receive higher sensitivity and immunity to multi-path. This ability allows the system to operate when there is no line –of – sight, a media where analog Video fails. The HB6100 is the smallest COFDM video transmitter in the market.

Specifications:

Frequency: L,S-Band
 Frequency Stability: ± 5 ppm
 Output Power : 27 dBm Linear (0.5W)
 Output Impedance: 50 Ohm ,VSWR 2:1
 RF Band-Width: 2.5MHz
 Video format: PAL/NTSC
 Modulation: QPSK
 ENCODING:MPEG2
 Bit Rate: 2.4MBPS Typical.
 Supply Voltage: 8 - 16Vdc
 Power consumption: <8W

ENVIRONMENTAL:

Temperature: $-25^{\circ}\text{C} \div +85^{\circ}\text{C}$

MECHANICAL:

Size: 70 x67 x23 mm (excluding connectors)
 Weight: 142 grm
 Connectors: RF –SMA FEMALE, Video, dc,-9 Pin MDM Connector

OPTIONAL

Audio input: 1 Vptp, STEREO
 ENCRPTION: AES128/256
 Video Encoding: MPEG 4
 MODULATION: 16-QAM.

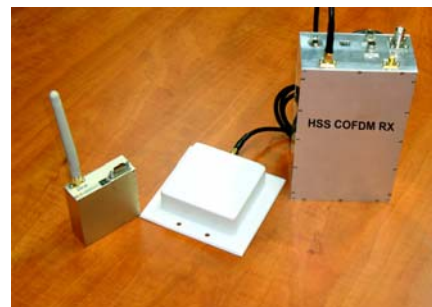



Miniature Analog Audio Video Transmitter Modules

Small sizes, low power consumption and high RF power

We offer wide variety of miniature analog video transmitters modules to be used together with any camera in your special projects.

We offer highly integrated circuit which allow high power output from 100mW – 1000mW !!!





Model	HSS-121800	HSS-241800	HSS-120500	HSS-240500	HSS-12020M	HSS-24020M	HSS-120200	HSS-240200
Frequency Band	1.2 GHz	2.4 GHz	1.2 GHz	2.4 GHz	1.2 GHz	2.4 GHz	1.2 GHz	2.4 GHz
No. of Channels	8 Ch.	8 Ch.	8 Ch.	8 Ch.	4 Ch.	4 Ch.	4 Ch.	4 Ch.
Audio Sub Carrier	5.5 MHz	6.5 MHz	5.5 MHz	6.5 MHz	5.5 MHz	6.5 MHz	5.5 MHz	6.5 MHz
Transmitting Range (apx.)	500 meter		200-500 meter		100-200 meter		100-200 meter	
Consumption Current	450 mA		450mA		280 mA		280 mA	
Output Power	1000 mW		500 mW		100 mW		200 mW	
Operating Voltage	12 V		5-5.5 V		5-5.5V		5-5.5V	
Power Supply	12V / 500 mA		5V / 500 mA		12V / 500 mA		12V / 500 mA	
Antenna Connector	SMA Connector		SMA Connector		Un-Detached Type		SMA Connector	
Weight	30 g		10 g		10 g		10 g	
Dimensions	26X50X13 mm		24X28X7 mm		21X24X7 mm		24X28X7 mm	
Picture (Actual Size)								



Analog Audio Video Transmitters With Housing and Self Powered

We offer wide variety of high power audio video transmitters to be used together with any CCTV camera.

We offer highly integrated circuit which allow high power output from 1W – 5 W !!!

Model	HSS-123000	HSS-243000	HSS-1230	HSS-2430	HSS-1255	HSS-2455	HSS-1218	HSS-2418
Frequency Band	1.2 GHz	2.4 GHz	1.2 GHz	2.4 GHz	1.2 GHz	2.4 GHz	1.2 GHz	2.4 GHz
No. of Channels	4 Ch.	4 Ch.	4 Ch.	4 Ch.	4 Ch.	4 Ch.	8 Ch.	8 Ch.
Audio Sub Carrier	5.5 MHz	6.5 MHz	5.5 MHz	6.5 MHz	5.5 MHz	6.5 MHz	5.5 MHz	6.5 MHz
Transmitting Range (apx.)	500-1000 meter		200meter		300-500 meter		500 meter	
Consumption Current	850 mA		350mA		450 mA		450 mA	
Output Power	1000 mW		200 mW		500 mW		1000 mW	
Operating Voltage	12 V		3.7 V		3.7 V		12 V	
Power Supply	12V / 2000 mA		5V / 2000 mA		5V / 2000 mA		12V / 500 mA	
Antenna Connector	SMA Connector		SMA Connector		SMA Connector		SMA Connector	
Hosing	Aluminum Alloy		Plastic Case		Plastic Case		Aluminum Alloy	
Battery lifetime/ charge time	N/A		100 minuts		120 minuts		N/A	
Weight	50 g		80 g		60 g		60 g	
Dimensions	65X60X35 mm		24X28X7 mm		78X66X15 mm		80X52X18 mm	
Picture								



Wireless Encrypted Audio Video Link

This state of the art device uses advanced digitally encryption method to provide secured video images over both cable and RF transition.

When used in RF applications the traditional problems if noise causing the system to fail have been erased, producing a very stable platform for trouble free use. Supplied a one devise containing an encryption unit and the RF sender in a ruggedly housed aluminum case. Complies with any CCTV camera.



1. Frq.: 1.2GHz / 2.4 Ghz
2. Channel: 8 CH's
3. Output: 1W/Min
4. Range: 150~400 Metres
5. Encryption: 2¹⁶ Times
6. Size: 54 x 82 x36 mm
7. Power: DC12V/1000 mA
8. Weight: 110g



1. Frq.: 1.2 / 2.4Ghz
2. Channel: 8 CH's
3. Switcher: Auto& Manual
4. Encryption :2¹⁶ Times
5. Size: 80x80x35mm
6. Power: DC12V/ 500 mA
7. Weight: 220g

How the system work

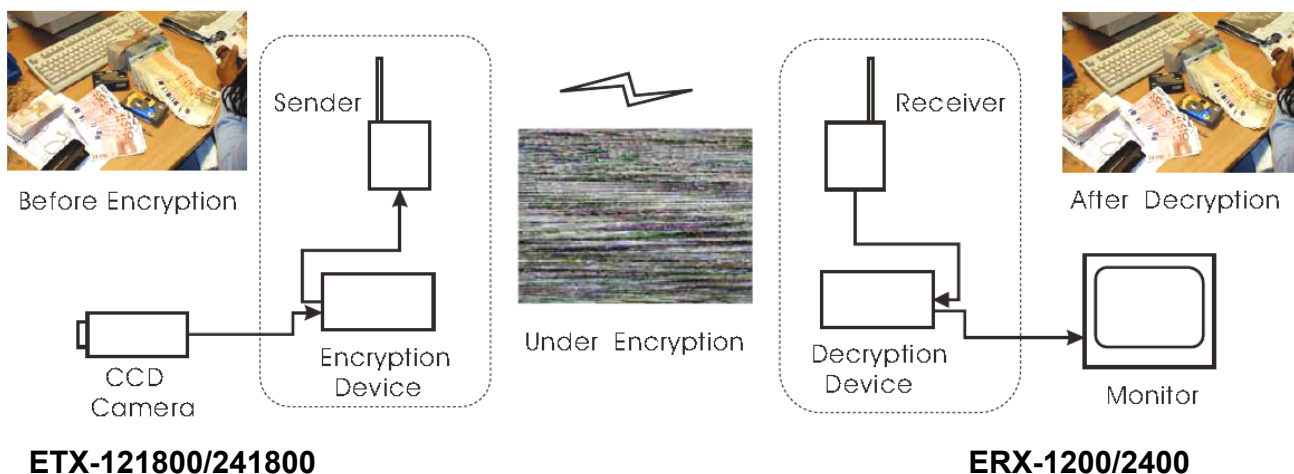

Simply connect the encryption devise to the video source output. The signal is then digitally encrypted using the cut an rotate encoded method. The encrypted video can then be transmitted securely. The video reciever output is then dycripted by the dycryption device before being viewed on the monitor.



Wireless Camera Hunter

Now In Two Sizes

Our all-new Wireless Camera Hunter locks onto any wireless camera transmission quickly and easily finding single or multiple hidden wireless cameras and lets you see what they see. The 2.5" color TFT high-resolution monitor displays the video image while the LCD window shows the exact frequency of transmission. Automatically scans all the commonly used video frequencies in less than 5 seconds and "locks-in" on any video camera transmitter and sounds an audible alert tone. Selectable antenna sensitivity allows "lock-in" on sources up to 500 of feet away (depending on power of source transmitter). Durable all metal case.

Specifications:

- Full Range Frequency Scanning from 900MHz ~ 2.52GHz
- 2.5" High Resolution Monitor
- LCD Display Shows Frequency and User Setting Details
- Full Range Video Protocol auto-switching for PAL / NTSC, CCIR / EIA
- Dual Power "AA" batteries or External AC adaptor (AC adaptor optional)
- Auto and Manual Scanning Modes
- "Fine Tuning" Rocker Switch for use after alert
- Battery life indicator on LCD
- Antenna Sensitivity Indicator on LCD
- Audible Alarm on/off Indicator on LCD





Stand Alone Fixed “Bug Detection” System

‘The Man Who Almost Broke The Bank’

The real threat to the Casino is the introduction of Bluetooth devices, wireless video transmitters that can be used with PDAs and mobile phones with video. Using this type of equipment requires the gamer to have a partner, typically in the same room, who can evaluate the table and make suggestions to his or her partner to increase the odds of winning. This is known as advantage gaming and until now has been impossible to detect.



Despite this sophistication, all these devices must transmit signals from the player to the partner and back. The detection of these signals is our business.

Casino Guard is a new concept, offering 24 hour, on-line protection of the gaming rooms. Whether you are being ‘attacked’ by radio listening devices, Mobile Phones (GSM, 3G), Bluetooth and W-iFi, you can be confident that the integrity of your gaming floors remains intact.

Real time protection means that detection will be made the instant the threat arises, enabling you to take appropriate action before any serious losses are incurred.



- Simple operation
- Detects all analogue and digital transmitters
- Integrated sensors optimises detection of suspicious devices
- Real time monitoring
- Signals can be filtered out, making it easier to interpret results
- User friendly set up
- Network compatible
- 24/7 protection
- Battery back up in case of power failure
- Alarm graphics enables quick identification of gaming area under threat

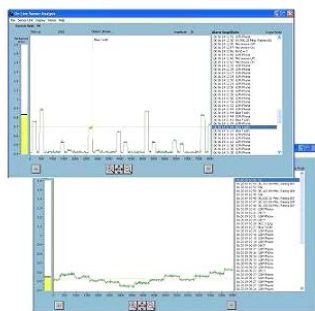



Multi Function Detector

For the first time four key methods of detection have been integrated into one easy-to-use unit designed to provide anyone with the ability to detect and locate electronic eavesdropping devices.

Just as protecting your computer requires action against different threats such as viruses and hacking, different types of electronic eavesdropping device require different methods of detection

Until now this has meant using several different types of equipment, each specializing in a different threat

Integrating four main detection methods, the Multi Function Detector provides the most comprehensive search tool available.



As well as addressing the various eavesdropping threats the combined sensors work together to enhance the search capability, providing a more complete picture of the search environment

Light and portable with an excellent battery life, the Multi Function Detector is easily transported and can be used with minimal training and is the ideal tool for securing today's business meeting.

Multi Function Detector – User Benefits:

- Designed for non-technical users
- Integrated use of sensors optimizes detection of devices
- Simplified presentation of complex information
- User-friendly touch-screen controls
- Clear indication of targets
- Simultaneous sensor sweep significantly reduce search time
- Cost-effective solution for bug detection
- Ergonomic light-weight design for comfortable operation
- Compact for easy transportation
- Integrated scanning receiver, non-linear junction detector, broadband receiver and metal detector.

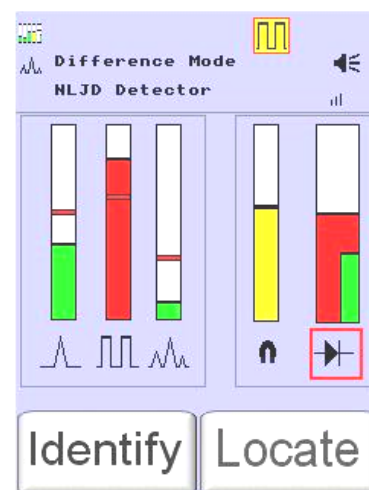



Counter Surveillance Receiver

When searching for active RF transmitter listening devices, speed is essential. If important meeting areas are under threat from electronic eavesdropping, minutes or even seconds could potentially be worth tens of thousands of pounds to an eavesdropper.

The detection and location of illicit RF transmissions requires swift and silent action to identify and locate listening devices on the Radio Spectrum without alerting potential eavesdroppers to what is happening



Our Counter Surveillance Receiver makes the detection, identification and location of covert radio transmitters quicker and easier than ever before
Imagine how long it would take to manually tune a radio into every station on the FM bandwidth to identify what was transmitting at each frequency
With our Counter Surveillance Receiver you can not only cover the whole FM bandwidth, but a 500 times wider bandwidth, all in less than 5 seconds
The Global Spectral Analysis Software adds a further dimension to identifying listening devices. The Counter Surveillance Receiver can be controlled remotely via telecommunication networks
Data can be saved directly to disk for further analysis; allowing multiple scan comparisons easily identifying any new and unusual bursts in activity
Compact and portable, the Counter Surveillance Receiver is easily transported and can be desk-mounted for continuous monitoring during meetings

Counter Surveillance Receiver – User Benefits

- Quickly identifies and locates active RF transmitters
- Simplified presentation of complex information
- Controllable externally via telecommunication networks to perform scans as required from any location
- Compact for easy transportation
- Cable checking function allows operator to check telephone and mains cables for listening devices
- Records identified legitimate signals, speeding up subsequent scans
- Desk-mountable to provide continuous monitoring during meeting
- Timer function allows regular scans of an area to be recorded for later analysis
- Graphic software spectral analysis for easy identification of suspicious devices

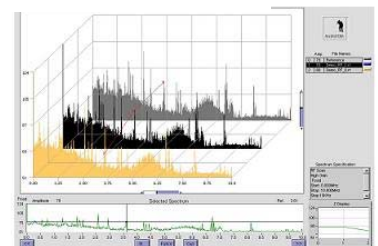



HSS- VDR Differential handheld RF detector

In areas of high RF activity, such as big cities, interference can make it difficult to pinpoint local active RF transmitters. When time is short and high-level emergency or external meetings are required it is essential to be able to quickly and easily locate active radio eavesdropping devices.

HSS- VDR is a handheld differential RF field-strength wide band detector. Rather than measuring the absolute field strength, HSS- VDR measures the rate of change in field strength. Ideal for use in areas with high RF activity, this technique provides a high degree of rejection of strong distant signal sources, providing greater discrimination against outside signals. The result is accurate location of active radio listening devices, wherever the meeting.



A Push Button is provided to reduce the sensitivity of HSS- VDR whilst working close to a local transmitter. This prevents a maximum response occurring too far from a transmitter to locate the source accurately. Portable, quick and simple to use, HSS- VDR is the ideal tool for quick location of active listening devices.

User Benefits

- Measures the rate of change in field strength, allowing active transmitters to be easily identified in areas with high RF activity
- Push-button sensitivity reduction to allow more accurate pinpointing of active transmitters
- Easy to operate for non-technical users
- Silent Operation option so that detection can be as discreet as the user chooses
- Highly versatile, ideal for locating radio bugs, basic RFI/EMC testing and localizing illegal high-power broadcast transmitters





HSS-M200 The Meeting Guard

Meeting Guard can be used to give real-time protection to meeting rooms, boardrooms etc. against the threat posed by radio eavesdropping devices.

The Meeting Guard is a fully configured real-time radio eavesdropping detection system built around the successful Room Guard sensor.

Having first swept the meeting room for eavesdropping devices, using for example the Multi Function Detector, the Meeting Guard can then be enabled to ensure that no radio eavesdropping devices are activated during the meeting.

The portable nature of Meeting Guard means that if meeting locations change your level of protection can remain the same.

The Meeting Guard system is available in two main variants; a fully portable solution comprising a Room Guard sensor, a semi-ruggedised laptop and power supplies housed in a smart briefcase, this system is hand portable and can be rapidly deployed and operated from within the case.

A semi-deployable solution comprising a Room Guard sensor, a semi-ruggedised laptop, power supplies, Room Guard sensor tripod and system carrying case, using this system the Room Guard sensor can be monitored from outside the sensitive area.



GSM EAVESDROPPING DEVICE



High performance long duration battery lifetime GSM audio bug's, ideal for remote locations and car monitoring,

Various of models are available:

- - Extreme Miniature GSM bug, for rapid hush environment installation
- - VOX and shock activation GSM devices, this device won't require the attacker to guess when a conversation is accruing, once the unit is triggered an alert is sent to a PDN,(Pre-defined number), so he can call the unit end eavesdrop the target, it is possible to adjust the microphone sensitivity to maximize the understanding ability.
- - Password protected units, to assure that only the authorized persons can listen to the specific device.



ANALOG EAVESDROPPING DEVICES

HSS-40 - UHF - USB CABLE TRANSMITTER

Battery life is always an issue with continuous investigation. Using USB as a power source, HSS-40 helps users to accomplish their purposes without worrying about battery. The other pro is that the HSS-40 is fully functional as a USB2.0 cable. It means that a transmitter can be set as a replacement for an connecting cable of ordinary USB devices such as printer, CD drive or external hard drive.

If there is no peripherals around, simply plug HSS-40 to a computer and put the other end wherever you want and it still works as a battery-less transmitter. All you need is an available USB port of a computer that is turned on and running.

Specification:

SIZE... Cable Length 1.5m

WEIGHT... 77g

POWER SUPPLY... USB bus power

BATTERY LIFE... N/A

AVAILABLE CHANNELS... UHF-A, UHF-B

MIC EFFECTIVE RANGE... 15m from circle point



HSS 700 UHF MODULAR TELEPHONE TRANSMITTER

HSS 700 provides continues conversation monitoring on targeted telephone, the transmitter takes its power directly from the line it self so no external power needed.

Specification:

SIZE... 16.5 x 22 x 37mm / Modular cable 10cm

WEIGHT... 9g

POWER SUPPLY... Telephone line current. No battery required.

AVAILABLE CHANNELS... UHF-A, UHF-B, UHF-C

INSTALLATION... Bridge connection between wall jack and telephone.



HSS-40 UHF LONG RANGE TRANSMITTER

High quality long range Audio Tx. easy one switch operation, High ratability, high sound quality, long range Tx & long term Tx makes the HSS-40 a great tool for gathering inelegance.

Specification:

SIZE... 30 x 18 x 70 (74)mm / Antenna Ø3 x 220mm

WEIGHT... 118g (with alkaline batteries) / Antenna 3g

POWER SUPPLY... "AA" (R6P / LR6) type battery (1.5V) x 2

BATTERY LIFE... Approx. 420h (alkaline) / Approx. 260h (man

AVAILABLE CHANNELS... UHF-A, UHF-B, UHF-C / SPECIAL

MIC EFFECTIVE RANGE... 15m from circle point

Tx RANGE Approx 200m (in side a city)





ANALOG EAVESDROPPING DEVICES

HSS-400 UHF MICRO SIZE TRANSMITTER

High quality micro size Audio Tx, No operation switch, just slide the battery into the unique HSS-400 slot & it's start working.

High ratability, high sound quality, long range Tx makes the HSS-400 a great tool for gathering inelegance.

Specification:

SIZE... 33(35) x 27 x 17.5mm / Antenna Ø3 x 185mm
WEIGHT... 10g (with a lithium battery) / Antenna 1g
POWER SUPPLY... Lithium button battery CR-2032(3V) x 1
BATTERY LIFE... Approx. 40h
AVAILABLE CHANNELS... UHF-A, UHF-B
MIC EFFECTIVE RANGE... 15m from circle point
Tx RANGE Approx 150m (in side a city)



HSS 802 UHF TRANSMITTER FOR DIGITAL TELEPHONE

HSS 802 enables you to monitor targeted line including digital phone. HSS 800 is set between a telephone main body and its handset The current on this part is lower than that of telephone line. So batteries are required to act

Specification:

SIZE... Ø15 x 500mm
WEIGHT... 49g(without batteries)
POWER SUPPLY... silver oxide button battery SR-48W(1.55V) x
BATTERY LIFE... approx. 6 hours



HSS 110/220 UHF 110V/220V TYPE TRANSMITTER

The HSS 110/220 room transmitter provides continues room monitoring once it connects to the 220V or 110V AC power wire, the HSS 110/220 supplied with two clip cord for fast installation.

Specification:

SIZE... 13.5 x 17 x 43mm / Clip cord
12cm
WEIGHT... 15g
POWER SUPPLY... AC220-240V (U-220CHIBI), AC100-110V (U-110CHIBI),
AVAILABLE CHANNELS... UHF-A, UHF-B, UHF-C
INSTALLATION... Parallel connection at mains lines. MIC EFFECTIVE RANGE...
15m from circle point





ANALOG EAVESDROPPING DEVICES

HSS-500 UHF MICRO SIZE TRANSMITTER

High quality micro size Audio Tx, No operation switch, just slide the battery into the unique HSS-500 slot & it's start working.

High ratability, high sound quality, long range Tx makes the HSS-500 a great tool for gathering inelegance.

Specification:

SIZE... Ø28 x 13mm / Antenna 90mm
WEIGHT... 11g (including battery)
POWER SUPPLY... Lithium button battery
CR-2032(3V) x 1
BATTERY LIFE... Approx. 30h
AVAILABLE CHANNELS... UHF-A, UHF-B
MIC EFFECTIVE RANGE... 15m from circle point
Tx RANGE Approx 150m (in side a city)



HSS-SLEEPER - CONTROLABLE TRANSMITTER

High quality controllable Audio Tx. The HSS-SLEEPER have a long battery life time- UP TO 1000h- stand by mode & control of the ON/OFF switch from a distance of approx 100m, The transmitter & the receiver have a unique code between them to avoid interference if more than one unit is working in the same surrounding.

Spectrum analyzers cannot detect the unit once it on the sleep mode.

High ratability, high sound quality, long range Tx makes the HSS-SLEEPER a great tool for gathering inelegance.

Specification:

SIZE... 67 x 21 x 70 (73)mm / Antenna Ø3 x 220mm
WEIGHT... 162g (with alkaline batteries) / Antenna 3g
POWER SUPPLY... "006P" (6F22/6LR61) 9V battery
x 1
BATTERY LIFE... Approx. 62h (6LR61, continuous transmission) / Approx. 1000h (stand-by mode, no
AVAILABLE CHANNELS... UHF-A, UHF-B
MIC EFFECTIVE RANGE... 15m from circle point
SIZE... 42.5 x 21 x 112 (120) mm / Rod antenna
20mm (shortened) - 460mm (extended)
WEIGHT... 162g (with alkaline batteries) / Antenna 3g
POWER SUPPLY... 9V battery x 1
BATTERY LIFE... Approx. 11h (6LR61, continuous)





HSS-10R UHF 3CH RECIEVER

The HSS-10R has DC9V input and Ø3.5mm earphone jack that matches to any earphone. On board DC9V input is very useful for a long hour receiving. Regular type is supplied with UHF-A, B and C channels. HSS-10R offer toughness, usability and high sound quality.



Specifications:

SIZE... 56 x 21 x 83 (99)mm / Antenna Ø10 x 190mm
 WEIGHT... Main body 195g (including manganese battery) / Antenna 8g
 POWER SUPPLY... 9V (6F22/6LR61) battery x 1 or AC adapter (DC9V)
 BATTERY LIFE... Approx. 30 hours (alkaline)
 RECEIVABLE CHANNELS... 3 channels; UHF-A, UHF-B, UHF-C
 INPUT & OUTPUT
 Antenna -SMA jack / Earphone output -Ø3.5mm monoral mini jack /
 Recording output -Ø2.5mm monoral mini mini jack / DC input -Ø2.5mm
 normal mini jack

HSS-100M UHF 2CH RECIEVER

HSS-100M is the most smallest receiver. It matches to our UHF transmitter. HSS-100M receives UHF-A and B channels.

Specifications:

SIZE... 45 x 19 x 63 (75)mm / Antenna Ø10 x 190mm, Ø10 x 73mm
 WEIGHT... Main body 165g (including battery) / Antenna 8g, 11g
 POWER SUPPLY... Lithium camera battery 2CR1/3 (6V) x 1
 BATTERY LIFE... Approx. 13hours
 RECEIVABLE CHANNELS... 2 channels; UHF-A, UHF-B
 INPUT & OUTPUT... Antenna SMA jack, earphone output-Ø2.5mm



HSS 100R UHF CARD RECIEVER

HSS 100R is the thinnest UHF receiver – only 6mm. Easy operation, just plug in the headphone antenna & it's starts working.
 Easy to hide & carry.

Specifications:

SIZE... 55 x 85 x 6mm , WEIGHT... 28g (with a lithium battery) /
 Earphone 7g
 POWER SUPPLY... Lithium button battery CR-430(3V) x 1
 BATTERY LIFE... Approx. 7h
 AVAILABLE CHANNELS... UHF-A, UHF-B, UHF-C





Wall Contact Microphone Sets

HSS-555 Multi Purpose

Ordinary wall contact microphone is not enough for your investigation kit, then we recommend you our newest model, HSS-555. HSS-555 is a multi functional wall contact microphone you can use it as a wall contact microphone / HSS-555 Equipped with hollow needle mic 2 different types of needles are supplied for max fitness to working surrounding.

Specifications:

SIZE... Amplifier unit 21(23) x 55 x 70 (85)mm / Contact mic. Ø32 x 27(30)mm Cord 97cm / Needle mic. Ø8 x 28mm (Mic. head) -Cord 105cm- (Needle Ø6 x 114mm, Ø6 x 57mm) / F-555EX 25m remote mic. Ø7 x 12 (Mic. head) -Cord 25m

WEIGHT... Amplifier unit 184g (with an alkaline battery) / Contact mic. 98g / Needle mic. 11g & 12g / F-555EX 25m remote mic. 147g

POWER SUPPLY... 9V (6F22 / 6LR61) battery x 1
BATTERY LIFE... Approx. 55-60h (alkaline)



INPUT & OUTPUT... Contact mic. input Ø2.5mm normal mini mini jack / Remote mic. power supplied input Ø2.5mm normal mini mini jack / Record output Ø2.5mm normal mini mini jack / Earphone output Ø3.5mm stereo mini jack.
OPTIONAL ITEMS... Remote microphone, 3m, 10m, 25m, 50m.

HSS-999 Super Sensitive

The flagship of our contact microphone, The HSS-999 have an advanced and improved stability of the amplifier circuit and also in durability of the board comparing to previews models. HSS-999 has Highly sensitive heavy brass metal microphone and Sound Filter -4 different band selectable, it has Limiter to protect your ear from sudden big sound.

Specifications:

SIZE... Amplifier unit 64 x 22 x 98mm / Microphone Ø36 x 30mm Cord 1m

WEIGHT... Amplifier unit 284g / Microphone 119g

POWER SUPPLY... 9V (6F22 / 6LR61) battery x 1

BATTERY LIFE... Approx. 50h (alkaline)

SOUND FILTER... 4 different band selectable. "0" = Through, "1" = Boost low band and decrease high noise, "2" = Boost high band decrease low noise, "3" = Boost targetted human voice.

SOUND LIMITER... Automatically cut sudden big noise. Normal sound level recovers after a couple of seconds.

INPUT & OUTPUT... MIC input Ø3.5mm monoral mini jack / Earphone output Ø3.5mm stereo mini jack / Record output Ø3.5mm monoral mini jack.

ACCESSORIES... Contact MIC guard plate, MIC extension cord, Contact MIC adhesive tape, Stereo Earphones.





SPY PHONE – GEN 5

HSS Ltd .distributes the most advanced remote monitoring software for mobile phones available. Completely stable and flawless in operation the Full Suite is a fully feature packed "security file" that intelligently operates in its own environment with absolutely no indication of installation logs, pre-defined number logging or any indication of connected calling. There is absolutely no tampering of the handset and no conflict with the normal operation of the handset whatsoever.

The Remote Control Management Tool is possibly the smartest addition to the software development. The remote control feature allows the PDN to send invisible commands, which are not recognized by the TP to control the activation, de-activation of the features and also change the pre-defined number at any time.

FEATURES

- **Spy phone** (listen in)
- **Text Forward**
- **Text Alert**
- **Call Interception**
- **Boot/SIM change**
- **Location** (SIM network dependant)
- **Reboot**
- **Uninstall**
- **Phone Dead**



Whenever the Target Phone makes or receives a call, a notification SMS is immediately sent to the PDN indicating the direction of call (incoming/ outgoing) showing the actual number of RP. At this moment the PDN has the option to make a call to the TP and intercept the conversation. The TP will create a conference and allow the PDN to listen clearly to both sides of the call.

COMPATIBLE MODELS

3230, 6600, 6260, 6620, 6630, 6670, 6680, 6681, 6682, 7610, N70, N72, N73, N80, N90, N91, N95, E50, E60, E61, E62, E70, 3250



Security Encrypted Mobile Phones

The fastest and easiest way to provide your customers with the power to engage in two-way, fully-encrypted, private cellular voice communication as well as sending and receiving encrypted text messages during any secure call.

This technology is available with even better audio quality than before supported by all of these popular Nokia phones: • Nokia 6630 • Nokia 6680 • Nokia N70 • Nokia N90

We ship these security phones to you in 2 ways:

1. The Complete Package – The Nokia phone is installed and shipped directly to your complete with the inscription software from Israel. All you do is deliver the phone to your customer. We remain transparent throughout the transaction and will never contact your customer directly.
2. The Software Package – The Nokia phone is locally purchased by you. We deliver the software directly to you by email along with our easy-to-use installer and simple instructions. You simply install the package into your customer's supported phone via choice of Bluetooth, infra-red, or data cable. No shipping costs, No import taxes, immediate delivery2..



How does it work?

Whenever a customer needs to make a secure call, or secure texts communication, he/she simply presses and holds the C button in the keyboard to initiate a fully encrypted session.

The call switches back to standard clear mode when the call is finished. Whenever the secure call is initiated, our software kicks in the encrypt the voice of text data using a constantly changing mathematical formula which creates a 1024 bit asymmetric key based on the RSA algorithm, as well as changing session key which replaces the encryption every second. Not only is the encryption software the perfect choice for politicians, lawyers, police and governmental agencies, executives, and anyone else who recognizes the need to prevent confidential information from falling into the wrong hands, but the encryption algorithms we use are so secure that our software has been licensed by the Israeli Ministry of Defense.

HSS UTMP 2 UNTRACEABLE GSM PHONE

To keep a conversation secure from interception possibilities of equipment connected directly to the switch, (so called lawful interception), it is not enough to purchase pre-paid SIM card and replace it every once in a while.

The interception equipment not only tracking the identity of the SIM card - IMSI, (International Mobile Subscriber Identity) , it also monitors the identity of the handset it self – IMEI, (International mobile equipment identity).

To make sure that the user is totally untraceable both IMEI and IMSI needs to be change together.

The HSS UTMP 2 mobile phone is modified in a way that every time the SIM card is replaced the IMEI will change automatically. The IMEI numbers produced by the cellular phone is random and will never repeat so the mission of intercepting the conversation becomes impossible.



The IMEI is a unique 15-digit code used to identify an individual GSM mobile telephone to a mobile network. This number can be displayed on most phones by dialing the code *#06#.

The numerical format of the IMEI code is: 111111-22-333333-4

TAC					FAC		SNR						CD	
D14	D13	D12	D11	D10	D09	D08	D07	D06	D05	D04	D03	D02	D01	

TAC – type approval code – this code identifies the country which type approval was sought for the phone as well as the approval no.

FAC – final assembly code – identify the company manufactured the mobile phone.

SNR – serial number – is a six digit code, which has been uniquely assigned to the specific type of hand set. The CD –check digit is use to check the IMEI for its validity for phase 2 and phase 2+ handsets. Phase 1 GSM handset always have '0' as check digit.



HSS-1210 ,HSS-1220 PRO MINIATURE WIRELESS EARPHONE



The HSS-1210 miniature earphone is a small wireless micro receiver that used with a hidden inductive loop that can be connected directly to a cellular phone or via a BT, (Bluetooth) adaptor. Combined with a sensitive microphone the system provides full two-way covert communication. When using a BT adaptor the phone can be up to 10m away from the user.

The unit is perfect for situation the user doesn't want anybody to know that he is connected online and getting info at real time.

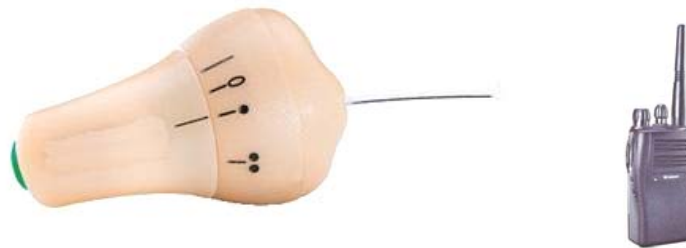

The HSS-1220 is a small miniature earphone that works with out the inductive loop. It provide only listening abilities once paring to a remote radio transmitter.

No wiring needed on the user, just the miniature earphone!!

The units are in use at Police surveillance, Privet investigators work, VIP security, lectures, meetings, secret prompter and even politicians...



IR ILLUMINATORS

We supply wide range of IR illumination Solutions. We have flood light illuminators or narro spot light illuminators. We have solutions for short range of few meters up to 400 meters.

All our illuminators are based on LED technology. Therefore we enjoy low power consumption, longer lifetime and smaller illuminators.

With the new LED technology that we use we can reach up to 100,000 hurs. Lifetime!

In order to prevent overheating of our illuminators we have built it into a special aluminum cases that released the heat and protect the illuminators. We do not use fans!!!

Another technology innovation that we used in the lens of the illuminator allows us to change the light angle with remote controller. This way a floodlight can be spotlight in a push of a button.

Advantages:

- Wide range of external and internal illuminators
- Wavelength 940nm cannot be seen by human eye, 88nm can see low red light
- All illuminators available in 880nm and 940nm wavelength
- Wide verity of concealed illuminators



IR-16



IR-294

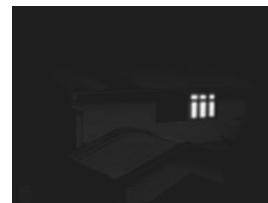

IR-84

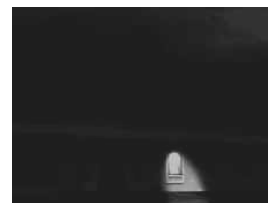
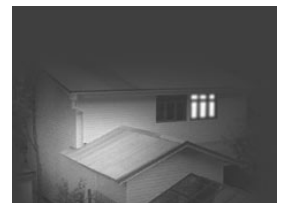

IR-21



Model	Illumination Angle (degree)	Illumination Range (meters)
IR-64	20	300
IR-16	20	60
IR-294	20	150
IR-112	20	100

Model	Illumination Angle (degree)	Illumination Range (meters)
IR-21	25	20
IR-56	25	35
IR-98	25	45
IR-84	30	45

Model	Illumination Angle (degree)	Illumination Range (meters)
IR112	120	12
IR-6	40	6
IR-Panel	170	4
IR-30	80	10



The CBR The Ultimate Professional Voice Recorder

The CBR is a state-of-the-art miniature solid-state recorder. The CBR is a miniature machine measuring approximately 60 x 55 x 18mm (2¼ x 2⅛ x ¾”) not including the removable battery compartment.



It is built in an aluminum case offering durability, and reliability second-to-none. The concept of the CBR is to offer unparalleled audio recording quality which is achieved in the CBR thanks to its exceptional microphone pre-amplifiers and filtering system. It uses high quality external microphones measuring less than 5mm (3/16”) in diameter and is also fitted with a single internal microphone, if external microphones are not appropriate. It is operated by a single programmable function button.

Equipped with an internal 2GB flash memory, the CBR can record over 150 hours of audio. The CBR is powered by two "AAA" cells, which are housed in a detachable battery compartment.

Special Features

- Fast set-up for ease of use
- PCM Linear or MPEG recording
- Internal / external microphones
- USB-2.0 communication
- SHA 1 authenticity encoding
- Recording / playback timers
- Rugged construction





The TINY series PROFFESIONAL MINIATURE DIGITAL VOICE RECORDER

Our miniature digital voice recorders are intended for professional recording of voice messages into flash memory.

The DVR features an extremely small size and weight, long record time varying with the model – from 36 to 300 hours, combined with very low power consumption the TINY is able to record up to 60h.

The TINY series offers wide frequency range (100- 10000Hz), wide dynamic range and a highly sensitive built-in microphone.

A built-in real time clock and a calendar are provided, as well as the mode of start-up by timer optional months of stand-by mode.

Due to the absence of moving parts, the DVR functions in a wide temperature range, under vibration and dusty conditions.

All feature are controlled by a special software and a USB link to the computer.

The TINY family offers several models:

- Stereo model - rechargeable
- Solar model
- 2 battery operated models

All models are available from 128Mb up to 2G.

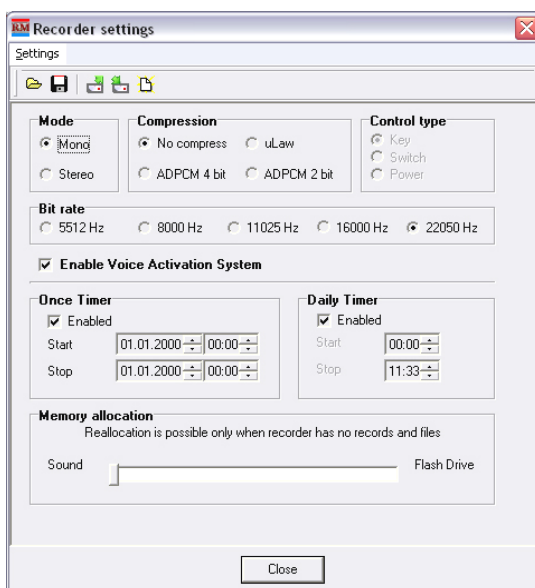



STING™ – MINIATURE MPEG2 PRO DVR

The STING™ Video Systems are Professional MPEG2 High Quality miniature Video recorders with wide variety of hidden cameras and concealed containers.

STING™ I

STING™ the original miniature feature packed Digital Video Recorder. Measuring just 78mm x 60mm x 23mm, including internal Lithium Ion battery, this unit can be used in multiple applications & countless scenarios requiring miniature high-quality video & audio recording.



STING™ II

Providing extensive wired and wireless communications options including, internet, GPRS, direct connection to monitor/television for playback. The Sting II™ also features built-in motion detection, file encryption, time-lapse recording mode, time / date stamp and watermarking and more.

Packaged in a 92 x 62 x 27mm housing, including lithium ion battery.



STING™ MINI

Sting Mini™, the smallest digital audio/video recorder in the Sting™ Range at only 60 x 40 x 18 mm. The Sting Mini™ includes an internal Lithium Ion battery and Time/Date stamp, features MPEG-2 compression and boasts full screen DVD image quality. It records on a 2 Gb SD card for up to 1 hour.



STING™ Accessories



Pen Cam



Button Cam



Earphone Cam



Necklace Cam



Bottle Cam



Tin Can Cam



Sting Xtreme™ Helmet Video Gear



The Sting Xtreme™ (helmet video gear) is HSS new revolutionary digital audio/video helmet recording system. What makes it revolutionary is that it a self contained modular system. No more interfering wires running from the helmet to the body! The high resolution camera and Sting® II digital recorder are both attached to the helmet. Furthermore, **The PATENT PENDING** clip-on attachment allows you to easily remove and reattach the system to almost any helmet in the market including Military, Police, Fire, Rescue, Ski and Motorcycle helmets among others.

The rugged, water resistant, shock absorbent and aerodynamic casing of the Sting Xtreme™ helmet video gear makes it exceptionally resilient in rough environmental conditions and makes it highly suitable for use in extreme work environments such as police, riot control, paratroopers, rescue units, extreme sports, etc.

The plug-and-play system can be connected to any display unit (monitor, TV, computer, etc.) for playback. Its 480 line resolution color camera provides high quality video in daylight and low light conditions. An optional video transmitter is available with this unit if live viewing at the control center is required

Features/Specifications

- Composite video output, which can be switched between live monitor view and recorded playback
- Media files can also be viewed on a PC-using any standard Window Media Players*
- MPEG-2 video compression in full D1 format and compression, supporting up to 8 mbit/sec video bit rate
- Water mark: Media files have a signature to verify that the video has not been tampered with
- Encryption: Media files can be optionally encrypted with a user-generated software key
- These files are viewable onboard with a password, or with a PC player after decryption
- Internal Lithium Ion rechargeable battery, which allows the Sting® II to operates for approximately three hours
- Video is embedded with a visible time/date, stamp in a configurable location Hi-speed USB 2.0 connector.
- Ethernet 10/100 port that supports the IP, TCP, UDP, DHCP protocols. Supports file transfer through a web interface from a remote PC
- Built-in vibrating motor with Failsafe video sync detect circuit, including end of memory & low battery warning





Rugged MPEG 2 Digital Video Recorder

SIMPLE PLUG AND PLAY. EASY TO USE!

PDR100 is a Personal Digital Recorder that converts your audio-video feed directly to high quality MPEG-2 format on a Compact Flash card.

- Typical 1gig CF card can hold approx 25-30 minutes of video at normal resolution!
- Video looping feature (user selectable) continuously records until stopped
- Able to trigger activate.
- Optional wired remote for easy power and start/stop recording. LED feedback on remote
- Powered by external 12VDC or internal Lithium AA batteries (four). Provides 12VDC power to external cameras (300ma max)
- On board high quality 2-channel microphone, user gain adjustable.
- Accepts external audio or common microphone inputs, user gain adjustable.
- Outputs in real time audio/video to external monitor and/or headphones
- Shock proof, ruggedized.
- Can use standard RCA jacks (with adapter) or MiniDin connectors
- Can be used for playback. Easy selection of files.
- Menu LCD and membrane switch panel for programming and selections.
- Easy. One single button to turn it on and off, and to start/stop recording.
- LED indicates power and record status. You always will know what the PDR is doing!
- Easily mountable to almost anywhere.
- Can use large capacity CF cards (16 gigabytes)
- Intelligent power supply can filter out dirty external power and voltage swings. Will sense power drop off and can switch to internal batteries.
- Approx 3.9" x 5" x 1.8", 14 ounces without batteries. 17 ounces with batteries.
- Built in connectivity to various data acquisition company products
- With lower datarate setting and smaller screen size setting, you can hold 24+ hours of video on a large CF Card. On a 16gig card, you could hold 40+ hours of video! Great for security use.
- RS-232 interface for future expansion and use with data acquisition





H.264 Mini DVR

Our H264 DVR is available in three different shapes for use in variety of applications: As a module, with standard plastic case and with aluminum rigid case.

Features:

- Resolution: 4CIF/ 2CIF/ CIF
- Pre-Alarm Recording
- Alarm In / Alarm Out
- Motion Detection / Schedule Setup
- SD Card as Data Storage: SDHC Support up to 8GB

Compression Format	H.264
Recording Resolution	4CIF (NTSC: 704X480, PAL: 704X576)
	2CIF (NTSC: 704X240, PAL: 704X288)
	CIF (NTSC: 352X240, PAL: 352X288)
Recording Quality(High)	4CIF:1500Kbps, 2CIF:1200Kbps, CIF:1000Kbps
Recording Frmate Rate	PAL: 25, 12, 8, 6, 5, 1 fps
	NTSC: 30, 15, 10, 6, 3, 1 fps
Recording Mode	Emergency / Schedule / Alarm / Motion Detection
Storage	Support SD, SDHC (8GB max.)
Maximum Recording File	2,000 files /Storage Device
AUDIO	
Compression Format	16bit PCM, 8KHz
Maximum Input	6 mVp-p @600ohm
Maximum Output	13mW@RL =16ohm, Unbalanced
ALARM	
Input	1 Ch. TTL(Internal full-up)
Output	1 Ch. TTL(Open collector)
ETC	
Searching Method	Time/Event
Operating Mode	Live/Playback/Menu
I/O, Power	
Multi in/Out Port	Pluggable Terminal Block(include Plug)
Alarm I/O	1Port, Pluggable Terminal Block(include Plug)
Remote Control Extend Port	Pluggable Terminal Block(include Plug)
Power consumption	Approx. 135mA @ 12VDC

Module



Standard Case



Rigid Case





PARABOLIC MICROPHONE

The HSS PRO10 Parabolic microphone designed for speech frequencies and max noise canceling. Although it can be fastened to a tripod, its design is to be hand held, it has an ergonomically-balanced soft foam handle which radically reduces hand noise.

The parabolic reflector is made out of 1mm transparent Macrolon. It is flexible and can be rolled into a cigar like shape and put into a shoulder strap soft case, Handle and microphone can be stored inside the parabola.

Without separate power supply, the HSS PRO10 connects to all voice recorders with 3.5mm mini Jack.



Diameter: 580mm, Weight: 0.85kg

HSS-7640 LASER REMOTE WINDOW LISTENING DEVICE

The system provides remote listening abilities through the window of the targeted room. Once we talk inside a room the sound waves hit the window and vibrate it. The system uses these vibrations by transmitting an invisible IR beam that reflects to a receiver that picks up the data and converts it to an electronic signal.

After the process the picked up speech is filtered, amplified and recorded. Both transmitter and receiver are built in standard single lens reflex camera for perfect concealment.



System Parts:

1. Laser transmitter
2. Laser Receiver
3. Amplifier unit with audio recorder



Laser Transmitter

Laser type – semi conductor
Laser wavelength – 750-840nm
Output power: 5mw auto controlled
Power supply- 8 X 1.5AAA batt (ext)
Current consumption: approx 100ma
Beam focusing: 135mm
Target finder- trough lens
Tripod standard mounting
10h continuous run time

Laser receiver

Laser type: noiseless PIN Diode
Wavelength infrared
Lens: 500mm
Power supply 9V
15-50-battery life time (according to volume)
Current consumption: approx 10-30ma

Amplifier unit: connected by cable with laser receiver, adjustable amplification, connection to Headphone/speaker, Voice filter equalizer, built in recorder.



HSS-4280 OPTICAL MICROPHONE



Professional sensitive fiber optic microphone, that captures from a soft whisper to a normal room conversation.

Due to a unique sensor technology the microphone provides excellent sound accuracy and performance.

A beam of light is sent through the fiber to a sound sensitive membrane, sound waves causes this membrane to vibrate and modulate the intensity of the light reflected from it, than the light is translated to an electrical signal.

The microphone provides a high SNR, (sound to noise ratio), so even low level sound inputs can be heard clearly from many meters away.

The HSS-4280 cannot be detected by electromagnetic means since the microphone head neither contains metal parts nor generates electromagnetic fields; the main unit is separate meters away from the monitored room by fiber optic cable.

The HSS-4280 can be installed in many ways to elude discovery by naked eye or highly sophisticated Non Linear Junction Detectors.

The HSS-4280 can be customized to your needs with the following variables:
Fiber length, type, color and different head types.



GSM Interception Systems

5.1

5.2

Real Time Passive

Semi Active

If you are looking for a Cellular Interception solution we are shore you are a little confused from all the systems and companies in the market. This is a huge market with numberless companies and agents selling systems and technology they do not really understand and know.

Let us help you to put some order in this chaos. Our professional staff will analyze together with you your specific needs. Then we will introduce you directly to the manufacturers of the systems, which will demonstrate the abilities of their system in your country.



We have partnership with wide range of cellular interception systems manufacturers. We do not work with agents so we will be able to offer you high quality service and support in fair costs.

No matter which system you are looking for active, semi-active, passive, real time passive systems or maybe CDMA or Satellite phone interception systems please contact us we will be more then happy to discuss it with you.



OPTIC INSPECTION SYSTEMS

H.S.S Ltd offers an extensive range of professional inspection and covert operations viewing systems. All instruments are sealed against ingress of water, oil and aviation fuel, and provides good resolution and system durability.

Rigid Endoscopes - with lengths up to 0.2m and diameters of 1.5mm-15mm, several viewing angle, 35° to 55° FOV, adjustable focus with a distance of 4mm to infinity and illumination connector.

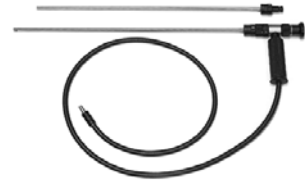

Flexible Endoscopes- (Borescopes) – with lengths up to 3000mm and diameters of 3.2,4,6,8mm, Tip articulation: 2 and 4 way direction with locking, FOV 60°, adjustable dioptr eye piece, depth of field 4mm to infinity and illumination connector.



Under door board – flat pack near IR lightning for room illumination, light output wavelength 940nm combined with a high sensitivity B/W camera connected to a 3.5mm semi-flexi scope. The image is displayed on a LCD screen. Optional voice recording capabilities.



Pole camera system – the pole camera system uses the latest CCD chip technology to optimize performance for fast search applications, the system are available both in monochrome or color and with covert IR or white light LED's. the products are perfect for inspecting cars, trucks, ceilings, pipes and even under water cameras up to 50m depth.



Video microscopes – hand held surface contact and / or stand mounted, color remote head CCD chip video format microscope. Magnification from 25X to 1000X, non contact probes, offer magnifying lens options from 5X to 200X





HSS Thermal Camera

We offer wide range top of the line high tech thermal cameras to be used as components in our integrated systems and as a stand-alone solution for specific needs.

SE 35 handheld Thermal Camera

The TACSIGHT™ SE 35 **handheld camera** provides night vision capability for civilian and paramilitary surveillance, detection and protection applications. TACSIGHT™ SE 35's powerful surveillance capabilities enable the user to effectively detect a person from a distance of over **650** meters and a vehicle from about **1300** meters.



HURRICANE Thermal Camera

The HURRICANE™ is an integrated electro-optical video system that combines a micro bolometric IR camera for night vision plus a CCD camera for daytime vision into a single, highly affordable bore-sighted unit. The system is ideal for monitoring sensitive locations or observing potential trouble spots. A key feature of Hurricane™ is that it can be fixed to a solid base at a particular observation point and connected to the display and centralized control, situated at a save distance. HURRICANE™ can also be vehicle-mounted for mobile reconnaissance and as a weapon sight.



EYE-M35 Thermal Camera

The EYE-M35™ is a small sized high performing thermal imaging engine based on a 320x240 pixels (35µm pitch) microbolometer detector. The EYE-M35™ supports both analog (CCIR or RS170) and optionally digital (LVDS or RS422) outputs. the long wave infrared band and has a sensitivity of under 0.07°C with an f/1.0 lens.



Qualification IP65 (IP 67- optional)



INVESTIGATION AEROSOL PRODUCTS

GUN SHOT POWDER RESIDUE TEST KIT (GSPR)



Is the newest critical crime scene investigative tool. GSPR allows a police officer to rapidly identify shooting suspects. GSPR is a simple and quick three (3) step test that provides immediate results to the question: "Did this suspect fire a gun?" This kit acts as a presumptive field test for residue containing nitrites which is typical to gun powder



FERROTRACE



Forensic science is often asked to demonstrate any physical link between suspect and firearm or tool. Ferrotrace has the amazing ability to make this link by detecting trace amounts of ferrous metal on skin, even to the point of outlining the metal object on the skin (e.g. gun handle or grenade). The chemical reaction between the ferrous metal residue and Ferrotrace creates a purple colored corollary that is in the pattern of the object that was held in the hands.



SEE THROUGH



See Through can make a letter transparent to allow one to see the contents even to the point of being able to read print inside. The product does not damage the letter or inks used. When See Through dries, no one knows that it has been used



a.

UV TRAP



UV Trap is a marking tool that leaves an invisible color residue on the surface that has been sprayed. When that surface is touched, the residue is transferred to the hands that touched the surface. Under the UV lamp, the residue is shown by a purple color on the skin. The residue will remain on the skin for some time, even when washed.



Blue



Blue is a unique tool for the development of footprints. Spraying directly on a non-porous surface will reveal the pattern of any undisturbed footprint that exists. The pattern will appear blue on a yellow background. It can be used on wooden, stone and linoleum floors and similar surfaces, which makes it an easy tool for footprint visualization, when casting is not an option.





BULLET PROOF PROTECTION GEAR

We supply a variety of military and security bullet protective products to accommodate the needs of our customers around out the world.

We are always happy to meet our customer's requests including custom made solutions.

Ballistic protection

HSS1642B HBA204 HSS1600 HSS1600 HSS1692 HSS1103 HSS-MTI



Ballistic protective clothing

HSS-UKS HSS9020 HSS9010 HSS9040 HSS9050 HSS1540 HSS405501



Ballistic plates

Famstone



Ceramic plate



Formal plate



anti knife stab



Bulletproof suitcase

Leather business briefcase



combat hames

HSS1995



HSS5200



HSS5100





Special Glasses Cameras

HSS-11488U

- Wearable Camera Hidden In sunglasses (UV Protection TYPE)
- 1/4" CCD COLOR ULTRA MINI camera
- Min. illumination :0.2Lux/F1.2
- OPTION : MICROPHONE
- Power Source: DC 12V



HSS-AD0199116C-4T

- 1/3" COLOR CCIQ GLASSES CAMERA
- Horizontal 380 TV Lines over W/ 3.9mm/F3.9 LENS
- Power Supply: DC 9 ~ 12V
- 2.4 GHz 10 mW
- AUDIO SUB CARRIER 6.5MHz



HSS-11466R-4T

- 1/4" CCD COLOR ULTRA MINI camera
- Pixel:250(NTSC) , 290(PAL)
- Min. illumination :0.5Lux/F1.4
- Power Source: DC 9-12V
- With 3.9mm/F3.9 lens



- 1/4" CCD color glasses camera
- Sony CCD color image sensor
- Min. illumination: 0.5Lux/F1.4
- Horizontal 360 TV Lines over 3.4mm / F3.4 (3T) , 3.9mm / F3.4 (4T) - optional
- Shutter Speed :1/50-1/100,000



HSS-11499

HSS-21488C

- UV Protection TYPE
- 1/4" COLOR CCD SONY Sensor
- Pixel:290K(PAL),250K(NTSC)
- Horizontal 350 TV Lines over
- Shutter Speed:1/50-1/100000
- W/ 3.1 mm/F3.4 LENS
- Power Supply : DC 9 ~ 12V



- 1/4" CCD COLOR ULTRA MINI camera
- Pixel:250(NTSC) , 290(PAL)
- Min. illumination :0.5Lux/F1.4
- Power Source: DC 9-12V
- With 3.1mm/F3.4 lens
- 100cm flexible cable between the mini lens and the slim camera Board



HSS-31466C-3T

HSS-21466SB-3T

- 1/4" CCD COLOR ULTRA MINI camera
- Pixel:250(NTSC) , 290(PAL)
- Min. illumination :0.5Lux/F1.4
- Power Source: DC 9-12V
- With 3.1mm/F3.4 lens
- 100cm flexible cable between the mini lens and the slim camera Board



- 1/4" CCD COLOR ULTRA MINI camera
- Pixel:250(NTSC) , 290(PAL)
- Min. illumination :0.5Lux/F1.4
- Power Source: DC 9-12V
- With 3.1mm/F3.4 lens
- 100cm flexible cable between the mini lens and the slim camera Board



HSS-31466U

HSS-31488Y

- Yellow tint sunglasses frame
- 1/4" COLOR CCD SONY Image Sensor
- Min. illumination :0.2Lux/F1.2
- OPTION : MICROPHONE
- Power Source: DC 12V



- UV Protection TYPE
- 1/4" COLOR CCD SONY Sensor
- Pixel: 290K(PAL),250K(NTSC)
- W/ 3.1 mm/F3.4 LENS
- Power Supply : DC 9 ~ 12V



Sp



ULTRA SMALL CAMERAS

HSS-L1475

- 1/4" CCD Color Snake Camera
- **With White LED Light**
- Pixel: 250K(NTSC) , 290K(PAL)
- Shutter Speed :1/50-1/10,000 Sec.
- Min. Illumination :0.2 Lux/ F1.4
- DC 12V
- focal distance 5cm for short distance purpose



HSS-L806

- 1/5" (PAL) or 1/6" (NTSC) Color CMOS Camera
- **With Light source**
- Pixel :109K(PAL) 73K(NTSC)
- Shutter Speed :1/50-1/57000 Sec.
- Min. Illumination :2 Lux/ F1.2
- DC 9 -12V
- diameter 9.2 mm
- focal distance 5cm for short distance purpose



1/4" COLOR CCD SNAKE CAMERA HSS-1870

- 1/4" CCD H.RES CAMERA
- SONY COLOR EXview CCD Image Sensor
- 25cm flexible cable between the mini lens and the slim camera Board
- Min. Illumination : 0.05 Lux / F1.2
- Pixel : NTSC-380k , PAL-410k
- Resolution : 470 TV Lines
- Dimensions : Lens-11x11x18mm, Board-29x29x7mm
- Power Source : DC 12V



HSS-T809BC

- 1/4" Color CMOS Camera
- 300K (NTSC & PAL)
- 380 TV Lines over
- 4.0 mm F2.0
- 0.3 Lux/ F1.2
- 60 fps
- DC 5 -12V
- 80 mA
- (D) 9.1 X 39 mm



HSS-R803-105, HSS-R803-55

- **Diameter: 4.4mm**
- **The smallest camera of the world**
- 1/18" Color CMOS Camera
- Pixel :320 x 240 (NTSC Only) QVGA
- Resolution : 240 TV Lines
- MO-R803-105 LENS: 0.77 mm/F3.0 FOV 105 Degree
- MO-R803-55 LENS: 0.96 mmF 2.8 FOV 55 Degree
- Min. Illumination :2 Lux/ F1.2
- Power : DC 9-12V
- Dimensions : 4.4mm



HSS-R833

- 1/18" Color CMOS
- Pixel :320x240(NTSC)
- 240 TV Lines
- Min. Illumination :2Lux / F1.2
- DC 3.3 V
- Dimension : (D)3.9 x 19 (mm)
- MO-R833-55 : 0.96mm/F3.0
- **shape memory goose neck + handlebar**



HSS-R803BC

- The smallest camera of the world
- 1/18" Color CMOS Camera
 - Pixel :320x240(NTSC)
 - 240 TV Lines
 - 0.77mm/F3.0
 - 2Lux / F1.2
 - DC 2.5 V



HSS-T833W

- 1/18" Color CMOS
- Pixel :320x240(NTSC)
- 240 TV Lines
- Min. Illumination :2Lux / F1.2
- DC 3.3 V
- Dimension : (D)3.9 x 19 (mm)
- MO-R833-55 : 0.96mm/F3.0
- **3 wire out**





Special Pinhole PTZ Mechanism and High Tech Pinhole lenses

These unique motorized pan and tilt mechanisms are specially designed for our line of zoom pinhole lenses. They pan either back and forth or up and down or both at approximately 120 degree angle each axis. Recommended lenses are the motorized pinhole lenses.

With these electronic optical zoom lenses plus this unique mechanism, you can pan and tilt your camera and zoom in and out to a particular subject at 4-20mm or 10-50mm range.

Units work with 5 VDC of power @500mA and are capable of lifting up to a 100g camera. Ideal cameras to use are C/CS mount B/W or color board cameras or enclosed cameras

The HSS-Z2 has 2-way movement and the HSS-Z4 has 4-way pan and tilt. Each comes with the necessary motors with leads ready to be wired to a control source (control source not included). Some of its unique features are: very low motor noise; compact in size; and easy to install.

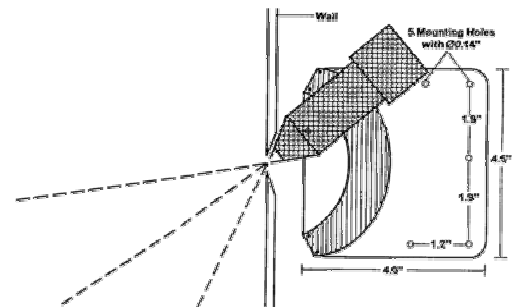

High Tech Zoom Pinhole Lenses

- 50mm Zoom
- Manual or Motorized Control
- Used for Many Industrial and Security Applications
- High Quality Glass Elements
- For 1/3" CCD with "CS" Mount
- Can operate from 7-12VDC
- Removable push-on cap also acts as mounting support





Long Focus Pinhole Lenses

High Tech Optical Design

150, 200 and 300mm

High Quality Glass Optics



These Long Focus lenses are designed for covert operations where it is necessary to have pinhole features while keeping the camera well away from the viewing tip. These can be used when looking through bushes or walls up to 14.81" thick

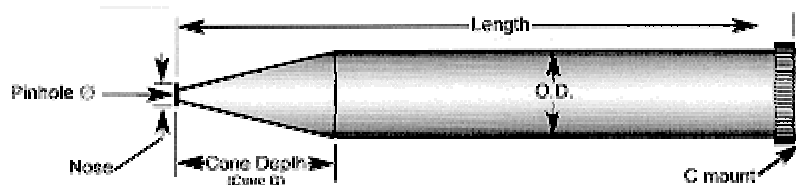

	HSS-150C	HSS-200C	HSS-300C
Focal Length	150mm	200mm	300mm
f-stop	f20-C	f20-C	f30-C
Format	2/3"CCD	2/3"CCD	2/3"CCD
Mount	C	C	C
Field of View (H×V×D)	3.25° × 2.45° × 4.10°	2.50° × 1.78° × 3.20°	1.68° × 1.25° × 2.30°
Nose	0.4"Ø	0.48"Ø	0.52"Ø
Pinhole Ø	0.1"	0.1"	0.17"
Cone D	1.57"	1.95"	2.50"
O.D × L	0.98" × 8.0"	0.98" × 10.81"	0.98" × 14.81"



Professional Microphones & Micro Audio Amplifiers

HSS develops and manufacture special micro audio amplifier designed to work with wide variety of microphone and specially design for NOLES professional products.

As we develop and manufacture our micro audio amplifiers we can adjust it exactly to the customers needs and special demands.

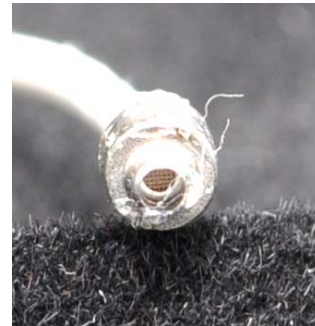

Miniature Microphones

HSS-3001W

- DC 12V 3 pin wire
- Output Frequency: 20 -16000Hz
- S/N ratio : more than 58 db
- W/50 cm cable 6x18x8 mm



HSS-3000F

- DC 12V RCA male
- Output Frequency : 20 -16000Hz
- S/N ratio : more than 58 db
- W/180 cm cable 6x18x8 mm



HSS-3300

- DC 12V RCA Female
- Output Frequency: 20 -16000Hz
- S/N ratio : more than 63 db
- W/50 cm cable 6x18x8 mm



HSS-3200HE

- **DC 12V(EXTRA POWER)**
- Frequency: 20 -16000Hz
- S/N Ratio:more than 58dB
- Impedance : 150 ohms ;20%:(at 1000 HZ)
- **With Wind Shield**



HSS-3003

- DC 12V RCA Female
- Output Frequency: 20 -16000Hz
- S/N ratio : more than 58 db
- W/50 cm cable 6x18x8 mm



HSS-3200E1

- DC 12V RCA Female
- Frequency: 20 -16000Hz
- S/N Ratio:more than 58dB
- Impedance : 150 ohms ;20%:(at 1000 HZ)
- **With Wind Shield**



HSS-6000

- DC 12V RCA male
- Output Frequency: 20 -16000Hz
- S/N ratio : more than 58 db
- W/50 cm cable 6x18x8 mm



HSS-3200E

- **DC 12V(EXTRA POWER)**
- Frequency: 20 -16000Hz
- S/N Ratio:more than 58dB
- Impedance : 150 ohms ;20%:(at 1000 HZ)





SPECIAL SERVICES

Eavesdropping Detection Service

As per your request, our professional and experienced technical team will perform Eavesdropping Detection Test anywhere in the world.

The test we perform is based on methodology developed during more the more then 30. our professional team is doing this kind of work on everyday basis in the last 30 years.

Our tests includes the following:

- Spectral check to detect local and nearby radio transmissions.
- Check of the room space to intercept implanted transmitters operating in VOX mode.
- Physical and Electrical check of telephones equipment and connection points.
- Check whether there is any carrier frequency coming out of the offices onto the external cable/line .
- Line-Balance check on direct lines to locate unauthorized connection
- Physical check of floors Intermediate connection boxes
- Check of Main connection box including the relevant extensions' connections.
- Physical check of the Switchboard.

The tests are usually performed in two phases:

- Spectral check during the day in standard operating hours of the premises.
- Rests of the tests are performed after work hours were no employees in the

Consulting & New Solutions Development

If you feel unsecured in your decision-making regarding a project you need to do, or you need a good advise from experienced and professional people in this field do not hesitate to contact us.

We have years of experience in our business. Maybe your new problem is not strange to us and we have already a very good solution.



IMPORTANT NOTICE

THIS CATALOG IS NOT AN OFFER FOR SALE

Some or all items above or some configurations of the items above may be restricted for sale to government or law enforcement agencies only.

The information and specifications presented herein are for informational and evaluation purposes only and do not constitute an offer for sale of these items.

An offer for sale can only be made by authorized company personnel in direct response to an official inquiry or purchase order made on the requesting agencies letterhead or official purchase order.

DISCLAIMER AND LEGALITY STATUS

You are responsible for deciding on the suitability of the goods offered for any particular purpose and for the consequences arising from your purchase and usage.

By purchasing or placing an order for any product through the HSS Ltd. website or Printed Catalog or by any other publications or any material connected directly and or indirectly with HSS Ltd. you are acknowledging that you fully understand and have consulted the legality status through a respected governing body in your country.

You are purchasing on the understanding that you have made all appropriate means to comply yourself and fully understand the applicable laws relating to such equipment used in this country or your own country and the consequences, which may be implied by their misuse.

HSS Ltd. will not be held responsible
for the usage of the products.

Use only at your own responsibility