

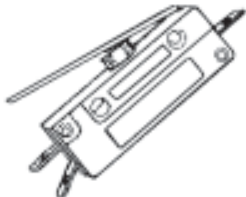

Dishwasher Parts

Exact Replacement Dishwasher Parts

General Electric

<p>WD3X749 DW154</p>	<p>WD6X130 ES16300</p>	<p>WD6X183 DW440</p>	<p>WD7X14 DW309</p>
			
<p>Soap Cup Door Spring</p>	<p>Door Switch</p>	<p>Door Switch</p>	<p>Door Cable</p>

General Electric

<p>WD8X181 DW155</p>	<p>WD8X227 DW156</p>	<p>WD8X228 DW157</p>	<p>WD12X235 DW143</p>
			
<p>Gate Arm Shaft Seal</p>	<p>Rightside Door Corner Gasket</p>	<p>Leftside Door Corner Gasket</p>	<p>Hub Bearing</p>

General Electric

<p>WD12X5028 DW144</p>	<p>WD19X10032 DW105</p>		<p>WD22X110 DW151</p>
	 <p>Rebuild Kit for WD26X10013</p> <p>Replaces: WD19X10032 WD19X62</p> <p>For pump assemblies that can be rebuilt.</p>		
<p>Sump Cover</p>	<p>Pump Rebuild Kit</p>		<p>Tower Gasket</p>

Part numbers and illustrations are intended solely for identification. Items offered for sale are not represented to be manufactured by the company that built the original model.

Dishwasher Parts

Exact Replacement Dishwasher Parts

General Electric

WD22X114 DW111	WD22X120 DW112	WD22X124 DW152	WD22X71 DW113
			
Spray Arm Support	Fine Thread Power Shower	Coarse Thread Power shower	Spray Arm Support

General Electric

WD26X10013 DW10013

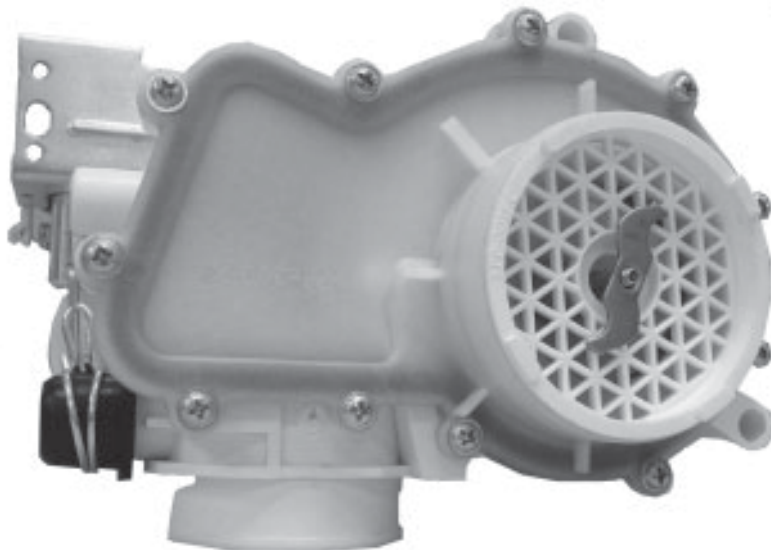

Dishwasher pump assembly used since 1970. Ready to install, solenoid and capacitor premounted. Necessary mounting hardware included with the pump assembly.

Replaces: WD26X10011,
WD26X10007
WD26X10003
WD26X77
& many more.

Need a pump rebuild kit?

WD19X10032 DW105



Replaces:
WD19X10032
WD19X62
For pump assemblies
that can be rebuilt.

Dishwasher Parts

Exact Replacement Dishwasher Parts

Whirlpool

300105
DW439

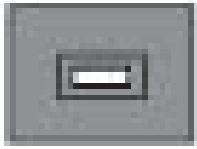

Soap Cup Shaft Seal

303919
ES16600

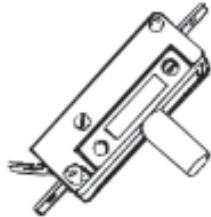

Interlock Switch

674744
DW307



Door Spring

675611
DW308



Door Spring

Whirlpool

716348
DW605



Upper Rack Roller

3367910
DW132



Spray Arm Nozzle Cap

4159914
ES16300

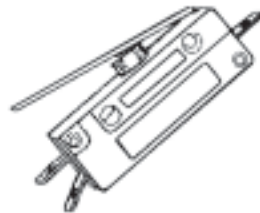

Door Switch

4160011
ES16100

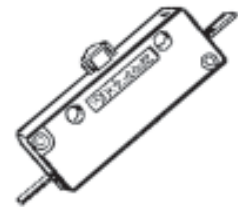

Door Switch

Whirlpool

4160496
DW303



Door Spring

4161629
DW304



Doorspring

4162322
DW610



Lower Rack Roller

4172010
DW606



4 Per Kit
Upper Rack Roller Kit

Dishwasher Parts

Universal Dishwasher Parts

<p>1161</p> 	<p>CUFA</p> 	<p>CUFE</p> 	<p>DWLC</p> 
<p>Faucet Snap Coupler Adapter</p>	<p>Straight Use with bulk hose 3/4", 1", 1 1/4" cutoffs Triple Connector</p>	<p>Right Angle Use with bulk hose 5/8", 3/4", 1 1/8" cutoffs Triple Connector</p>	<p>Use with bulk hose 3/4", 1", 1 1/4" cutoffs Triple Connector</p>
<p>DW804</p> 	<p>SD75125</p> 	<p>SSDW7</p> 	<p>SSDW100</p> 
<p>Connector GDK1 / GDK2</p>	<p>3/4", 1", 1 1/4" cutoffs Universal Connector</p>	<p>5/8" X 7 feet 5/8", 3/4", 1 1/8" cutoffs Universal Drain Hose</p>	<p>100 feet Bulk 5/8" PVC Hose</p>
<p>SSDWK</p> 	<p>UDA125</p> 	<p>Garbage Disposal Parts</p>	
<p>100 feet bulk hose 24 ea. DWLC connectors 1 can PVC Cement Universal Drain Hose Kit</p>	<p>Dishwasher to Disposal Universal Drain Adapter</p>	<p>LP670</p> 	<p>LP671</p> 
		<p>Splash Guard</p>	<p>Splash Guard</p>

Part numbers and illustrations are intended solely for identification. Items offered for sale are not represented to be manufactured by the company that built the original model.

Washer Parts

Exact Replacement Washer Parts

Alliance

20129
LP515



Boot Seal

23540
ES16200

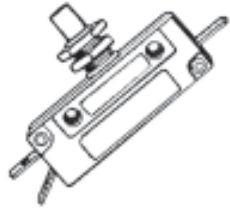

Door Safety Switch

27612
ES16807

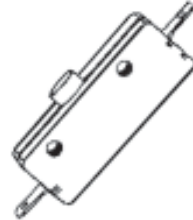

SPST Lid Switch

562P3
LP1586



Anti-Siphon Kit
Reference: 297P3 & 386P3

Alliance

34963P
GVW151

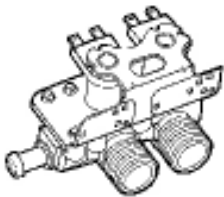

120V Water Valve
3/8" & 1/2" adapter

200937P
LP127



Direct Drive Pump
Reference: 36863P

Electrolux

131208500
GVW151

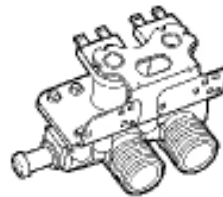

120V Water Valve
3/8" & 1/2" adapter
Reference: 5303207418
5308006679

131862900
DE788



Idler Pulley
Reference: 3204422

Electrolux

134049200
SSD8



Universal Drain Hose

5300184701
ES16200

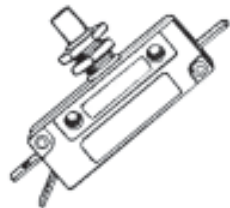

Door Safety Switch
Reference: 5303261027

5303912510
LP118



Franklin Style Pump
Reference: F133058

5303912530
LP394



Tub Grommet

Washer Parts

Exact Replacement Washer Parts

General Electric

WH1X1944
LP301



Drive Spline
Fine shaft (20 Teeth)

WH1X1986
LP701



Spline Coupling

WH1X2089
LP216



Lid Switch Actuator

WH1X2721
LP217



White Selector Knob
1 3/4" dia. 1/4" D shaft
Flat Left
Red Indicator

General Electric

WH1X2727
LA189



Tub Dampening Strap
Approx. 6" Long

WH1X2760
LP227

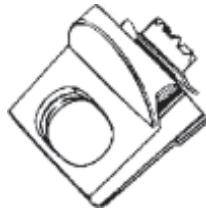

Chrome
Washer Knob

WH1X484
LP933



Foot Pad

WH2X10032
LP10032



New Style Tub Seal

General Electric

WH8X10018
LP510



Star Boot
Reference: WH8X246

WH8X281
LP604

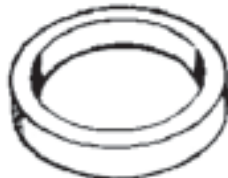

Lower Shaft Seal
for Transmission

WH8X291
LP602



Agitator Shaft Seal
(Seal Only)

WH8X291K
LP603





Agitator Shaft Seal Kit
(2 Pcs.)

Part numbers and illustrations are intended solely for identification. Items offered for sale are not represented to be manufactured by the company that built the original model.

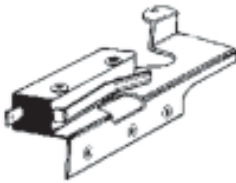
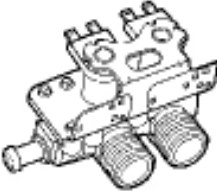

Washer Parts

Exact Replacement Washer Parts

General Electric

<p>WH8X305 LP656</p>	<p>WH12X494 LP211</p>	<p>WH13X81 GVW151</p>	<p>WH16X513 LA188</p>
 <p>Main Upper Tub Gasket Black Rubber</p>	 <p>Lid Switch Assembly</p>	 <p>120V Water Valve 3/8" & 1/2" adapter Reference: WH13X76</p>	 <p>Plastic Retainer Clip Used after 1995 to hold drain hose</p>

General Electric

<p>WH23X10013 LP129</p>	<p>WH23X42 LP112</p>	<p>WH41X35 GNBA</p>
 <p>Pump & Motor Assembly Reference: WH23X10003</p>	 <p>4 Hose Pump WH23X53 (conversion kit Included)</p>	 <p>Aluminum Drain Hose Nozzle for plastic order GNB</p>

General Electric

<p>WH41X367 SSD6GE</p>	<p>WH43X87 LP949</p>	<p>WH43X102 LP948</p>	<p>WX5X1325 TB123A</p>
 <p>No Kink Drain Hose 4 ft order SSD4GE 6 ft order SSD6GE 8 ft order SSD8GE</p>	 <p>Agitator Short 15 1/2" Tall</p>	 <p>Agitator Long 17" Tall</p>	 <p>Universal Washer Wrench for GE, Maytag, & Whpl.</p>

Part numbers and illustrations are intended solely for identification. Items offered for sale are not represented to be manufactured by the company that built the original model.

Washer Parts

Exact Replacement Washer Parts



Maytag

<p>015494 LP349</p>	<p>201112 LP920</p>	<p>201537 LP347</p>	<p>201809 ES16600</p>
			
<p>0A4298 LP348</p>	<p>Anti-Siphon Kit for kit with 4' extender order LP5834</p>	<p>Boot Seal Mounts between inner and outer tub</p>	<p>Older Models Long Stem Lid Switch</p>
 <p>Agitator Shaft Seal</p>			

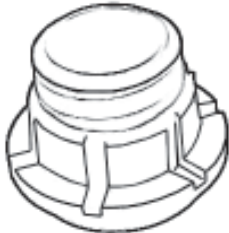
Maytag

<p>202203 LP117</p>	<p>22204012 LP340</p>	<p>204013 LP341</p>
		
<p>Washer Pump Newton Style</p>	<p>Mounting Stem Seal Kit Reference: 204012 & 2-4012 Order TB123A to install / remove.</p>	<p>Lower Tub Bearing Kit Reference: 2-4013</p>

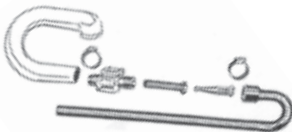
Maytag

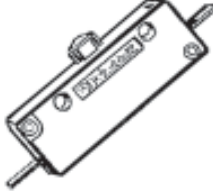
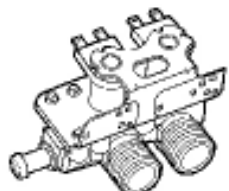

<p>204660 LP663</p>	<p>205000 LP921</p>	<p>204415 ES16100</p>	<p>205613 205614 33-2374N GVW151</p>
			
<p>Water Injector Kit for older style Newton models with rubber inlet hose</p>	<p>Glide & Spring Kit Reference: 2-5000</p>	<p>Lid Switch (2 terminal) Used after 1967</p>	<p>120V Water Valve 3/8" & 1/2" adapter</p>

Part numbers and illustrations are intended solely for identification. Items offered for sale are not represented to be manufactured by the company that built the original model.



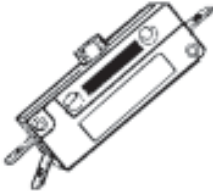

Washer Parts

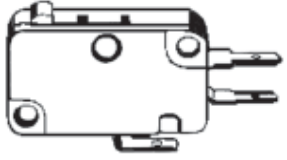
Exact Replacement Washer Parts





Maytag

<p>205416 ES16301</p>	<p>206154 LP585</p>	<p>206680 LP</p>	<p>207166 ES7166</p>
 <p>Lid Switch (3 terminal) 1950's to Current Reference: 33-3382</p>	 <p>Injector Tube Older Style Newton Rubber Side Mount</p>	 <p>Water Injector Kit for newer style Newton models with plastic inlet hose</p>	 <p>Check Switch Used in 2201682</p>

Maytag

<p>211726 LP923</p>	<p>212989 LP956</p>	<p>213013 LP665</p>	<p>213015 LP580</p>
 <p>Lid Hinge Ball Newton Models</p>	 <p>Tub to Pump Hose Approx. 15" Long</p>	 <p>Valve Hose Inlet to Injector</p>	 <p>Injector Nozzle Used in both old & new</p>

Maytag



<p>214765 LP992</p>	<p>215235 LP668</p>	<p>216016 LP991</p>	<p>216201 LP581</p>
 <p>Siphon Break Gasket Used with 216016</p>	 <p>Injector Tube Newer Style Newton Plastic Inlet</p>	 <p>Siphon Break Elbow Gasket included</p>	 <p>Injector Valve Used: 204660 & 206680</p>

Part numbers and illustrations are intended solely for identification. Items offered for sale are not represented to be manufactured by the company that built the original model.

Washer Parts

Exact Replacement Washer Parts

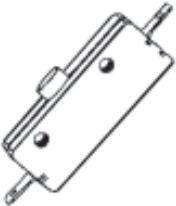

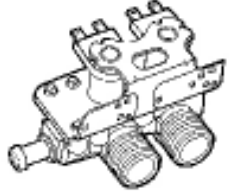

Maytag

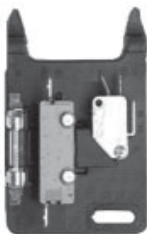
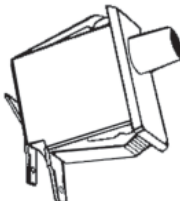
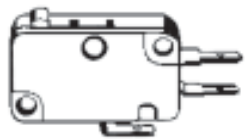
<p>12001187 ES16807</p>	<p>12001586 LP1586</p>	<p>12002533 LP2533 (Grey)</p>	<p>22001274 GVW151</p>
			
<p>Use with plastic or metal bracket Ref: 33-9064, 21001137</p>	<p>Antisiphon Kit Has sleeves for new style plastic drain hose</p>	<p>Door Boot w/drain Ref: 12001772, 22001978 Can be used to replace Black Boot 22003898</p>	<p>120V Water Valve 3/8" & 1/2" adapter</p>

Maytag

<p>22001682 ES682</p>	<p>22002044 ES16806</p>	<p>22002162 ES7166</p>
		
<p>New Style Lid Switch Assembly Complete with both switches and 4 amp fuse See 205415 & 207166 for individual switches</p>	<p>Tub Displacement (Out of Balance) Switch</p>	<p>Door Switch Lock / Spin Enable Front Loader</p>

Maytag

<p>22002263 10C7</p>	<p>21001873 LP128</p>	<p>21001906 LP123</p>	<p>27001233 LP127</p>
			
<p>Lamp (in latch) Used in Washer & Dryer</p>	<p>New Style Pump with metal plate Reference: 21002240</p>	<p>Late Model Pump Top Inlet Reference: 21001732</p>	<p>Direct Drive Pump Reference: 27001036 40040301</p>

Part numbers and illustrations are intended solely for identification. Items offered for sale are not represented to be manufactured by the company that built the original model.

Washer Parts

Exact Replacement Washer Parts

Whirlpool

21365
LP953



Cap Washer

21366
LP331

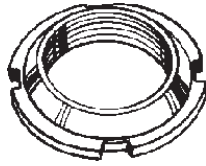

Drive Block Nut
Use with 96384
or 389140
Wrench order TB123A

76660
LP920



Anti-Siphon Kit
for Calypso Kit
order LP5834

76673
LP655



Tub Repair Kit
4 Bolts
4 Washers
4 Fiber Washers

Whirlpool

80040
LP338



Agitator Dog
Order 12 pack
80040D = LP338D
Reference
285770, 285770D

84867
89814

Control Magnet
Only order LP246



Control Magnet
w / Kit order LP247

85114
LP932



Foot Pad

91938
LP631



Center Post
Upper Seal
O.D. - 1 9/16"
I.D. - 1 3/16"
Thickness - 9/16"

Whirlpool

91939
LP632



Upper Shaft Seal
O.D. - 1"
I.D. - 3/4"
Thickness - 1/2"

93553
LP598



Outer Tub Grommet
"Button Trap"
2 3/4" I.D.

93770
LP617



Old Style Lid Bumper
All Rubber

95440
LP928



Drain Elbow
with Snap Lever

Part numbers and illustrations are intended solely for identification. Items offered for sale are not represented to be manufactured by the company that built the original model.



Washer Parts

Exact Replacement Washer Parts



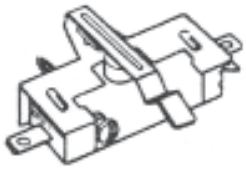

Whirlpool

<p>96384 LP332</p>	<p>99618 LP730</p>	<p>123931 TB123A</p>	<p>239453 ES16400</p>
			
<p>Drive Block Belt Drive Models 2 5/32" Tall Tub Nut Order LP331</p>	<p>Bearing & Seal Kit Used on Early Models 2 bearings, 2 lip seals, and 1 tube seal</p>	<p>Wrench Set to Remove Tub Nut Also for GE & Maytag</p>	<p>Motor Switch 5 terminal Replaces: 298800 Sears 80443</p>

Whirlpool

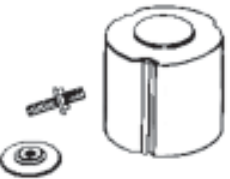
<p>279173 LP173</p>	<p>279347 LP210</p>	<p>285134 LP731</p>	<p>285206 LP988</p>
			
<p>Universal Push to Start Switch Kit</p>	<p>Lid Switch Kit Order LP985 (691581) for lever only Reference: 350484</p>	<p>Bearing & Seal Kit Later Belt Drive Models 2 bearings, 2 lip seals, and 4 tube seals</p>	<p>Direct Drive Washer Agitate Gear Cam</p>

Whirlpool

<p>285285 LP951</p>	<p>285317 LP115</p>	<p>285320 LP1586</p>	<p>285671 ES671</p>
			
<p>Agitator Cap Kit White with bolt</p>	<p>3 Hose Pump Belt Drive Models used on models that do have lint filter</p>	<p>Antisiphon Kit Plastic Drain Hoses or Rubber Drain Hoses includes inserts</p>	<p>Lid Switch Assembly Round Terminals 24" Wire 14" Tube</p>

Part numbers and illustrations are intended solely for identification. Items offered for sale are not represented to be manufactured by the company that built the original model.

Washer Parts

Exact Replacement Washer Parts

Whirlpool

<p>285672 LP925</p>	<p>285748 LP254</p>	<p>285753 LP337</p>	<p>285811 LP285</p>
			
<p>Spring & Seal Kit For Agitator shaft in gearcase assembly Reference: 92814</p>	<p>Agitator Cam Kit Includes: 4" Cam Thrust Spacer 4 dogs</p>	<p>Motor Coupler Replaces earlier versions Order LP337HD to replace Heavy Duty - Commercial 285852</p>	<p>Agitator Cam Kit Includes: Medium Cam Thrust Spacer, & 4 Dogs Repl: 285746 & 285751</p>

Whirlpool

<p>285834 LP5834</p>	<p>285852 LP337HD</p>	<p>350365 LP113</p>	<p>350367 LP114</p>
			
<p>Antisiphon Kit for Calypso Includes 4 " Extension Hose</p>	<p>Heavy Duty - Commercial Motor Coupler Replaces earlier versions Reinforced Rubber Isolator</p>	<p>2 Hose Pump Belt Drive Models used on models that do not have lint filter</p>	<p>4 Hose Pump Belt Drive Models used on models that do have lint filter</p>

Whirlpool





<p>350920 LP319</p>	<p>355519 LP218</p>	<p>356500 LP219</p>	<p>356934 LP630</p>
			
<p>T- Bearing Main Transmission Thrust Bearing</p>	<p>Chrome Timer Knob 1/4 - 20 Threads No Extension Replaces White 355643</p>	<p>Chrome Timer Knob 1/4 - 20 Threads Used 1974 to 1984</p>	<p>Transmission Stem Seal O.D. - 1 9/16" I.D. - 1 3/16" Thickness - 1"</p>

Part numbers and illustrations are intended solely for identification. Items offered for sale are not represented to be manufactured by the company that built the original model.

Washer Parts

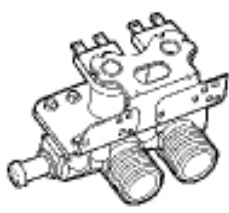
Exact Replacement Washer Parts

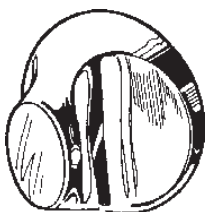



Whirlpool

<p>358276 GVW151</p>	<p>359449 LP634</p>	<p>359507 LP220</p>	<p>383727 LP633</p>
			
<p>120V Water Valve 3/8" & 1/2" adapter</p>	<p>Agitator Shaft Seal O.D. - 1 9/16" I.D. - 1 1/8" Thickness - 1/4"</p>	<p>Chrome 1/4 - 20 Threads 1/4" Extension</p>	<p>Outer Tub Main Seal (Tub Center Grommet) Reference:96690</p>

Whirlpool

<p>358336 LP318</p>	<p>389248 SM389248</p>	<p>482156 CS189-227X110</p>
		
<p>Snubber Pad Stabilizes tub during spin cycle</p>	<p>Speed Washer Motor 1/2 horsepower 1725 rpm on high 1140 rpm on low CS189-227X110 (482156) Capacitor separately</p>	<p>Start Capacitor Used on 2 & 3 Speed Direct Drive Washer Motors</p>

Whirlpool

<p>691581 LP985</p>	<p>3357027 GBNA</p>	<p>3348552 HP421</p>	<p>3349985 LP986</p>
			
<p>Switch Actuator Used with LP210</p>	<p>Aluminum Goosneck Plastic Gooseneck</p>	<p>Pump to Drain Connector Hose</p>	<p>Transmission Top Seal O.D. - 1 3/4" I.D. - 1 1/4"</p>

Part numbers and illustrations are intended solely for identification. Items offered for sale are not represented to be manufactured by the company that built the original model.

Washer Parts

Exact Replacement Washer Parts

Whirlpool

3352287
SM3352287



3 Speed Washer Motor
Order Capacitor Separately
CS189-227X110 (482156)

3355806
LP901



3 Coil Water Valve
Whirlpool / Sears
Typically Models with
Detergent Dispenser

3362624
LP225



2" Black Timer Knob
1 1/8" Metal Center
1/4 - 20 Threads
Replaces Almond Also

Whirlpool

3363394
LP116



2 Hose Pump
Direct Drive Models
Standard Outlet
no Check Valve

3363892
LP121



2 Hose Pump
Direct Drive Models
Oversize Outlet
has Check Valve

3364290
LP226



2 1/4" Black Timer Knob
1 3/4" Black Center
1/4 - 20 Threads

3364291
LP228



2 1/4" White Timer Knob
1 3/4" White Center
1/4 - 20 Threads

Whirlpool

3364293
LP234



2 1/4" Almond Knob
1 3/4" Almond Center
1/4 - 20 Threads

3949247
ES247



Lid Switch Assembly
3 Flat Terminals
27" Wire 14" Tube

4391969
SSD6



No Kink Drain Hose
4 ft. order SSD4
6 ft. order SSD6
8 ft. order SSD8

8318084
ES8084



Lid Switch Assembly
3 Flat Terminals
Harness plugs on to switch

Part numbers and illustrations are intended solely for identification. Items offered for sale are not represented to be manufactured by the company that built the original model.

Universal Hoses & Accessories

Universal Washer Drain Hoses

Features:

- Universal Design
- Economic
- Fits hundreds of models



SSD6

Supco No.	Size	Connector Style	Step Down	Description
SSD4	1" X 4'	Straight	1", 1 1/8", & 1 1/4"	Universal
SSD4GE	1" X 4'	G.E.	1", 1 1/8", & 1 1/4"	GE Style, Order LA188 Clip
SSD6	1" X 6'	Straight	1", 1 1/8", & 1 1/4"	Universal
SSD6GE	1" X 6'	G.E.	1", 1 1/8", & 1 1/4"	GE Style, Order LA188 Clip
SSD8	1" X 8'	Straight	1", 1 1/8", & 1 1/4"	Universal
SSD8GE	1" X 8'	G.E.	1", 1 1/8", & 1 1/4"	GE Style, Order LA188 Clip



GNB

Build Your Own Drain Hose

- Step 1 Cut bulk hose to length
- Step 2 Use PVC cement to attach drain connector
- Step 3 Use PVC cement to attach gooseneck
- Step 4 Add antisiphon kit when needed



SSD50

Supco No.	Package	Description
SSD50	1" Dia.X 50 Feet	Bulk Washer Drain Hose
CUFA	1" X 1 1/8" X 1/ 1/4"	Universal Straight Connector
CUFE	1" X 1 1/8" X 1/ 1/4"	Universal 90° Connector
GNB	1" I.D.	Plastic Gooseneck
LP1586	Antisiphon Kit for Plastic Drain Hose	



CUFA

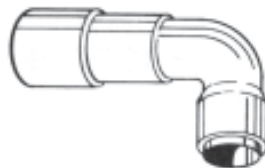

CUFE



LP1586

Hose Screens & Washers



LA094

Hose Washers

Supco No.	Package	Description
LA094	12	Green Stripe
LA100	100	Green Stripe



LA095

Hose Screens

Supco No.	Package	Description
LA095	25	30 Mesh Monel
LA091	100	30 Mesh Monel
LA096	25	60 Mesh Monel
LA092	100	60 Mesh Monel

Universal Hoses & Accessories

Accessories for Rubber Drain Hoses



GNBA



HL103



HM101

Supco No.	Description
GNBA	Aluminum 1" Dia. Gooseneck for rubber drain hose
HL103	90° elbow Hose Mender, for sharp bends - White
HM101	Straight Hose Mender - White
LP920	Standard Antisiphon kit for rubber hoses
LP1586	Antisiphon kit for rubber or plastic drain hoses
LP5834	Antisiphon kit with 4" extender, used on Calypso and Maytag



LP920



LP1586



LP5834



HYP38

"Y" Mixer Hose

HYP38 This high pressure mixing hose allows a washer to operate normally when only a cold water supply is available. Attach to water valve and fill hose.



3803FF

Washer & Dishwasher Inlet Hose

- Pressure tested to 800psi (cold) - 600psi (hot)
- Double crimped fittings for strength and safety
- Ozone resistant to prevent rubber decay
- Product Liability Insured



3803FE

Length	Female X Female	Female X 90° Female	Male X Female
3 Feet	3803 FF	3803 FE	3803 MF
4 Feet	3804 FF	3804 FE	3804 MF
5 Feet	3805 FF	3805 FE	3805 MF
6 Feet	3806 FF	3806 FE	3806 MF
8 Feet	3808 FF	3808 FE	
10 Feet	3810 FF	3810 FE	
12 Feet	3812 FF	3812 FE	



3803MF

New! PVC Inlet Hoses

- Built in washers
- Heat fused ends to prevent leaks
- Nylon couplers never rust or corrode
- 90° ends for tight spaces



3804FEPV

Supco No.	Length
3804FEPV	4 Feet
3805FEPV	5 Feet
3806FEPV	6 Feet

Exact Replacement Dryer Parts

Exact Replacement Dryer Parts Alliance Dryer Thermostats

OEM No.	Supco No.	Style	Temp. °F	Diff.°F	Term
51185	SET102	FL	325	50	2
51386	LD130	LD	130	15	3
51387	LD155	LD	155	20	3
51879	LD120	LD	120	15	3
51880	LD120	LD	120	15	3
51880A	LD145	LD	145	20	3
51897	SET110	L	120	10	2
52393	SET121	LD	145	20	3
52394	SET109	L	135	15	2
53708	SLF155VA	SLF	155	40	2
54736	LD120	LD	120	15	3
54737	SET153	LD	135	15	3
55742	SET133	F	300	50	2
56082	SET183	L	300	40	2
56115	SET110	L	110	10	2
56410	LD140	LD	140	20	3
56440	SET105	L	140	10	2
61372	FLD135	FLD	135	15	3
400011	L225	L	225	40	2
400198	L170	L	170	20	2
400199	L150	L	150	20	2
400209	L225	L	225	40	2
400296	L135	L	135	15	2



Style FL



Style FLD



Fuse



Style L

OEM No.	Supco No.	Style	Temp. °F	Diff.°F	Term
431177	L340	L	340	40	2
500807	LD120	LD	120	15	3
502498	L15510W	LW	155	10	4
503551	L15525W	LW	155	25	4
503552	L15510W	LW	155	10	4
503554	L15525W	LW	155	25	4
503979	LD135	LD	135	15	3
504237	FL225	FL	225	40	2
504514	L15510W	LW	155	10	4
504515	L15510W	LW	155	10	4
504516	L120	L	120	10	2
504517	L15525W	LW	155	25	4
504518	L155	L	155	20	2
504519	L14520W	LW	145	20	4
510701	FL225	FL	225	40	2
510702	SLF255VA	SLF	255	50	2
511412	SET182	Fuse	360	Fuse	2
M401254	SET105	L	140	10	2
M401255	SET129	L	165	2	2
M401256	L175	L	175	20	2
M401257	L200	L	200	40	2
M401258	L225	L	225	40	2
M4D9433	SET107	L	340	40	2



Style LD



Style LW



StyleSLF

Thermostat Kit 490P3 SET200



490P3 kit is used with 61927
For High Limit only see 510701 above
For Thermal fuse only see 511412 above
Reference: 511412 is also a 767511412

"M" Series Gas Valve 58804 25M0A-100



White
Rodgers



OEM No.	Supco No.	Orifice	Size
58804	25M01A-100	*#44	(.086)
60667	25M01A-100	#40	(.098)
62959	25M01A-100	#44	(.086)
504091	25M01A-100	*#42	(.0935)
60353P	25M01A-100	*#40	(.098)

*Use old orifice holder with new valve & orifice
Designed by White Rodgers to replace the "M" series clothes dryer valves. Kit shown is a right angle left outlet valve (RAL). Kit is a direct replacement valve with 8 orifices (6 Nat. & 2 LP), 2 bushings, and 2 nuts.

See 58804A & 58804B for replacement coils.

Dryer Parts

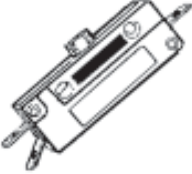
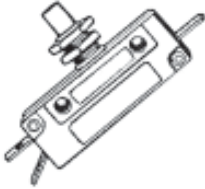

Alliance

<p>369P3 SDE359</p>	<p>33445 ES16301</p>	<p>51143 ES16200</p>	<p>51835 DE793</p>
			
<p>Round Igniter Spring Mount References: 54608, 56970, 58823, & 60868,</p>	<p>Coin Meter Switch Reference: 00-6103, 00-6163, 9128-1, M400001 T183-56</p>	<p>Dryer Door Switch Reference: 430540</p>	<p>Blower Wheel Shaft Smaller Blower Wheel</p>

Alliance





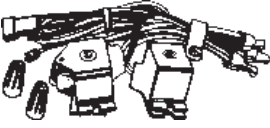
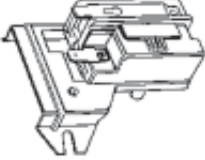

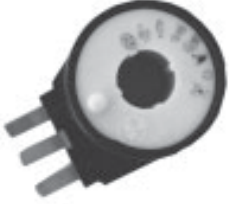

<p>52079 DE794</p>	<p>53001P DE795</p>	<p>53132 DE791</p>	<p>53519 DE910</p>
			
<p>Drum Shaft Bearing</p>	<p>Drum Roller Shaft Left Side</p>	<p>Drum Roller Shaft Right Side</p>	<p>Blower Wheel Shaft Larger Blower Wheel</p>

Alliance

<p>54410 DE783</p>	<p>55428 SDE350</p>	<p>56225A DE381</p>	<p>56231 DE353</p>
			
<p>Idler Pulley Assembly Reference: 54415P</p>	<p>Round Ignitor Reference: M402743 Used 1981 and after</p>	<p>"K" Series Coil Kit Reference: 5303261027</p>	<p>I.R.Sensor Ref: M402742 & M402366</p>

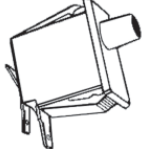
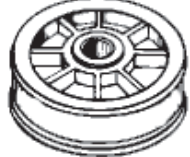
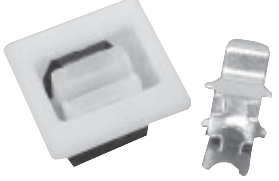
Part numbers and illustrations are intended solely for identification. Items offered for sale are not represented to be manufactured by the company that built the original model.

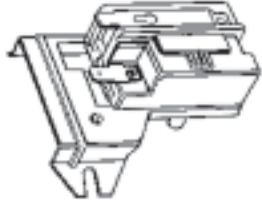
Dryer Parts

Alliance			
56461 DE796	58804A DE382AWR	58804B DE382BWR	60954 10C7
			
Drum Roller Shaft Used with 62649 Roller	Boost Coil 3 Terminals for "M" Series valve	Secondary Coil 2 Terminals for "M" Series valve	10 Watt Lamp
Alliance			
62649 DE691	504570 ES16806	510124 DE407	510177 DE902M
			
Drum Roller Used with 56461 Shaft	Switch Used on later models Reference: 56052, 62872, 430542, 504570 70107001, & M406119	Idler Pulley 54410 for pulley w/arm	Latch & Catch Kit Metal Latch Plastic Catch
Alliance			
510184P SDE364	510213 DE353	M400945 ES15807	M400947 DE947
			
Flat "M" Style Igniter Rapid Response Direct plug-in no bracket	I.R. Sensor Ref: M402742 & M402366	Permanent Press Toggle Switch	Cool Down Coin Meter Switch

Part numbers and illustrations are intended solely for identification. Items offered for sale are not represented to be manufactured by the company that built the original model.

Dryer Parts

Electrolux Dryer Thermostats

OEM No.	Supco No.	Style	Temp. °F	Diff. °F	Term		OEM No.	Supco No.	Style	Temp. °F	Diff. °F	Term
3204267	FL260	FL	250	50	2	 FL Style	5308001690	L150	L	150	20	2
3204307	L135	LDC	135	15	2		5308013213	L135	L	135	15	2
131298300	L14515W	Multi	140	15	4		5308013213	L135DC	LDC	135	15	2
134048800	L13515W	Multi	135	15	4		5308013595	SET104	FL	205	40	2
134120900	SLF222VA	SLF	222	40	2		5308015847	L145DC	LDC	155	20	2
131298400	L14515W	Multi	145	15	4		5308015856	FL200	FL	200	40	2
5300131743	SET119	LD	225	40	3		5308950121	SET104	FL	205	40	2
5300169845	LD120 & HA11	LD	120	10	3		5309951548	SET115	FL	240	50	2
5300169849	LD140 & HA11	LD	140	20	3		F30191	LD225	LD	225	40	3
5300169850	LD155 & HA11	LD	155	20	3		F32148	LD130	LD	130	15	3
5300169851	LD120 & HA11	LD	120	15	3	F36589	L205	L	205	40	2	
5300169853	LD135 & HA11	LD	135	15	3	F66908	L130	L	130	15	2	
5300169857	LD210 & HA11	LD	210	40	3	F76613	LD200	LD	200	40	3	
5300169858	LD240 & HA11	LD	240	40	3	F79198	L205	L	205	40	2	
5300169860	LD305 & HA11	LD	305	40	3	F132206	SET119	LD	225	40	3	
5300633905	L200	L	205	40	2	F65802-1	L150	L	150	20	2	
5300634209	L190	L	190	40	2	K1025647	L125	L	125	10	2	
5303211472	SLF330VA	SLF	330	50	2	K1027198	L225	L	225	40	2	
5303281034	L13515W	L	132	15	4	K1030890	L180-40	L	180	40	2	
5303281113	FL285	FL	285	40	2	K1031140	SET119	LD	225	40	3	
5303320997	SET105	L	140	10	2	K1034218	SET105	L	140	10	2	
5307531200	L13515W	L	135	15	4	K1035672	LD130	LD	130	15	3Style	
5307531201	L13510W	L	135	10	4	K1035674	L250	L	250	40	2	
5307531358	FL320	L	320	50	2	K1036048	L130	L	130	15	2	



Style LD



Style LDC



Multi-Temp



Style SLF



HA11 Adapter

Electrolux

“M” Series Gas Valve 25M0A-100

White Rodgers Direct Replacement Gas Valve Kit

Designed by White Rodgers to replace the “M” series clothes dryer valves. Kit shown is a right angle left outlet valve (RAL). Kit is a direct replacement valve with 8 orifices (6 Natural Gas & 2 LP), 2 bushings, and 2 nuts. Valve is a direct replacement, correct orifice included. Used since 1984.

White
Rodgers



25M01A-100

This genuine White Rodgers valve kit is designed to replace all right angle left outlet 25M series valves.

OEM No.	Supco No.	Orifice	Size
58804	25M01A-100	*#44	(.086)
60667	25M01A-100	#40	(.098)
62959	25M01A-100	#44	(.086)
504091	25M01A-100	*#42	(.0935)
60353P	25M01A-100	*#40	(.098)



Need a replacement coil kit for the “M” series valve?

Both Coils in a kit

For Electrolux 5303931775 order the direct replacement coil DE382WR

Booster / Holding Coil (3 terminal)

For Electrolux Q622601 order the direct replacement coil DE382AWR

Secondary Coil

For Electrolux Q622602 order the direct replacement coil DE382BWR











Part numbers and illustrations are intended solely for identification. Items offered for sale are not represented to be manufactured by the company that built the original model.

Dryer Parts

Electrolux			
<p>3937010 DE339</p>  <p>Dryer Restring Kit Reference: 131475300</p>	<p>131825900 DE727</p>  <p>Bearing Reference: 5303281008</p>	<p>134394900 SDE358</p>  <p>Igniter Reference: 134192000</p>	<p>5300137504 DE520</p>  <p>Lint Screen</p>
Electrolux			
<p>530017854 DE381</p>  <p>Coil Kit for "K" Series</p>	<p>5300234600 DE338</p>  <p>Dryer Restring Kit</p>	<p>5300622032 DE335</p>  <p>Dryer Restring Kit Reference: Q622032</p>	<p>5300622034 DE336</p>  <p>Dryer Restring Kit Reference: Q622034</p>
Electrolux			
<p>5301167945 DE414</p>  <p>Drum Support Roller Kit Set of 5</p>	<p>5303161103 DE413</p>  <p>Idler Pulley Assembly</p>	<p>5303281044 ES16806</p>  <p>Door switch</p>	<p>5303281049 DE766</p>  <p>Felt Seal</p>

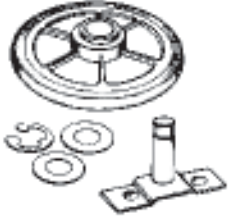
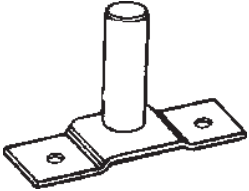
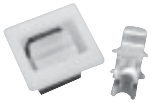
Part numbers and illustrations are intended solely for identification. Items offered for sale are not represented to be manufactured by the company that built the original model.

Dryer Parts





Electrolux			
5303281135 DE353	5303281153 DE724	5303931775 DE382WR	5303937139 DE790
			
Infrared Flame Sensor	Tub Bearing Kit	2 Coil Kit for "M" Series	Drum Felt with Glides Reference: 131154800 3201208, 5303211431
Electrolux			
5303937186 SDE364	5304440277 SDE350	5308057415 DE695	5308057416 DE694
			
Universal Flat Igniter "M" style with connector, wire nut kit included.	Round Igniter Reference: 5300600831 5301126982	Side Drum Roller Reference: F141888	Center Drum Roller Reference: F141724
Electrolux			
5308057417 DE699	5366021400 DE902M	5379499000 DE784	F133850 DE787
	 Metal & Plastic DE902 		
Roller Shaft for Center Drum Roller	Plastic Latch & Catch Kit	Idler Pulley Assembly	Idler Pulley Reference: F133850-000

Part numbers and illustrations are intended solely for identification. Items offered for sale are not represented to be manufactured by the company that built the original model.

Dryer Parts

General Electric

Dryer Thermostats

OEM No.	Supco No.	Style	Temp.°F	Diff.°F	Term		OEM No.	Supco No.	Style	Temp. °F	Diff.°F	Term
WE4M80	L290	L	290	40	2		WE4X587	SET188	L	140	15	2
WE4M127	SET187	L	135	15	2		WE4X589	L145	L	145	20	2
WE4M136	FL240	FL	240	50	2	Style FL	WE4X590	L135	L	135	15	2
WE4M137	SET800	LSP	310	80	2		WE4X591	L140	L	140	20	2
WE4M156	L125	L	125	10	2		WE4X592	SET192	L	300	40	2
WE4M160	SET104	FL	210	40	2		WE4X593	L300	L	300	40	2
WE4M216	L13510W	Multi	135	10	4	Fuse	WE4X594	L140	L	140	20	2
WE4X133	SET163	L	155	20	2		WE4X595	L155	L	155	20	2
WE4X151	L225	L	225	40	2		WE4X596	L130	L	130	15	2
WE4X254	SHF140	SHF	140	40	2		WE4X597	LD130	LD	130	15	3
WE4X255	L130	L	130	15	2	Style L	WE4X599	LD130	LD	130	15	3
WE4X256	L175	L	175	40	2		WE4X600	L145	L	145	20	2
WE4X257	L225	L	225	40	2		WE4X601	L135	L	135	15	2
WE4X258	SLF170VA	SLF	170	40	2		WE4X607	L145	L	145	20	2
WE4X261	L180-40	L	180	40	2	Style LD	WE4X608	L135	L	135	15	2
WE4X275	SET164	L	260	40	2		WE4X639	L205	L	205	40	2
WE4X291	SET189	L	155	25	2		WE4X670	L130	L	130	15	2
WE4X292	SET117	LD	155	20	3		WE4X690	L120	L	120	10	2
WE4X293	L270	L	270	40	2	Style SLF	WE4X691	SET187	L	135	15	2
WE4X295	LD145	LD	145	20	3		WE4X711	FL200	FL	200	40	2
WE4X323	LD170	LD	170	20	3		WE4X715	L145DC	LDC	145	20	2
WE4X324	SET192	L	300	40	2		WE4X755	L135	L	135	15	2
WE4X325	SET101	SLF	170	25	2	Style LDC	WE4X757	FL260	FL	260	50	2
WE4X325	SLF170VA	SLF	170	40	2		WE4X774	SLF222VA	SLF	222	40	2
WE4X339	SET129	L	165	20	2		WE4X800	SET800	LSP	310	80	2
WE4X340	L325	L	325	40	2		WE4X811	SET187	L	135	15	2
WE4X394	L325	L	325	40	2	Style LSP	WE4X812	SET193	L	325	50	2
WE4X395	SET188	L	140	15	2		WE4X813	SET190	L	230	40	2
WE4X396	SET153	LD	135	15	3		WE4X818	L130	L	130	15	2
WE4X419	SET189	L	155	25	2		WE4X819	L125	L	125	10	2
WE4X422	L165	L	165	20	2	Style Multi	WE4X820	SET193	L	325	50	2
WE4X429	LD140	LD	140	20	3		WE4X824	L145	L	145	20	2
WE4X454	L145	L	145	20	2		WE4X856	SET189	L	155	25	2
WE4X485	L145	L	145	20	2		WE4X857	SET401	Fuse	196	2
WE4X497	SET192	L	300	40	2	Style SHF	WE4X5040	L225	L	225	40	2
WE4X498	SET189	L	155	25	2		WE4X5091	SET105	L	140	10	2
WE4X510	L340	L	340	40	2		WE4X5098	L130	L	130	15	2
WE4X543	SET191	L	250	40	2		WE4X5099	FL260	FL	260	50	2
WE4X544	L130	L	130	15	2	WE4X5135	SET121	LD	145	20	3	
WE4X545	L340	L	340	40	2	WE4X5136	LD155	LD	155	20	3	
WE4X546	SET188	L	140	15	2	WE4X5137	SET144	FL	250	50	2	
WE4X547	L130	L	130	15	2	WE4X5176	FL260	FL	260	50	2	
WE4X549	L145	L	145	20	2	WE04X10002	FL260	FL	260	50	2	
WE4X550	L135	L	135	15	2	WE04X10018	L14515W	Multi	145	15	4	
WE4X551	L140	L	140	20	2	WE04X10028	L14515W	Multi	145	15	4	
WE4X552	SET192	L	300	40	2	WE04X10055	L180-20	L	180	20	2	
WE4X582	LD145	LD	145	20	3	WE04X10099	L13515W	Multi	135	15	4	
WE4X583	SET189	L	155	25	2	WE25X139	L155	L	155	20	2	
WE4X584	SET191	L	250	40	2	WE25X161	SET137	L	130	15	2	
WE4X586	SET187	L	135	15	2	WE25X167	SET163	L	155	20	2	

Part numbers and illustrations are intended solely for identification. Items offered for sale are not represented to be manufactured by the company that built the original model.

Dryer Parts

General Electric

"M" Series Gas Valves

25M0A-100 & 25MA-101

White Rodgers Direct Replacement Gas Valve Kit



Designed by White Rodgers to replace the "M" series clothes dryer valves. Each kit is a direct replacement valve with 8 orifices (6 Natural Gas & 2 LP), 2 bushings, and 2 nuts.



25M01A-101 Right Angle Left Outlet

OEM No.	Supco No.
WE4X708	25M01A-101
WE4X709	25M01A-101
WE11X10009	25M01A-100
WE14X171	25M01A-101
WE14X207	25M01A-101
WE14X214	25M01A-101
WE14X215	25M01A-101
WE14X229	25M01A-101
WE14X10012	25M01A-100
WE14X10046	25M01A-101

Note: Match orifice to original or use old orifice. Special applications may require use of old orifice holder.



25M01A-101 Right Angle Right Outlet

Need a replacement coil kit for the "M" series valve?

Both Coils in a Kit	
OEM No.	Supco No.
WE04X10004	DE382WR
WE04X10020	DE382WR
WE04X10031	DE382WR
WE04X10048	DE382WR



Booster / Holding Coil (3 terminals)	
WE4X692	DE382AWR

Secondary Coil (2 terminals)	
WE4X693	DE382BWR

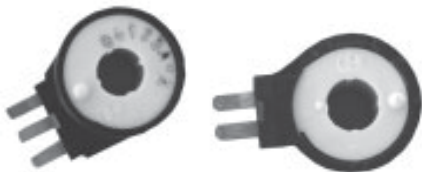

DE382WR



DE382AWR



DE382BWR

Genuine White Rodgers Coil kits are designed to replace coils on the 25M series valves.



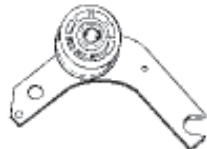
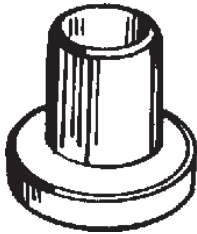

Dryer Parts

General Electric			
WE1M463 DE771	WE1M481 DE775	WE1X759D DE400	WE1X1201 DE773
			
Door Handle White Plastic Door Handle 4 3/8" X 1 1/2"	Teflon Front Glide 2 3/4" X 5/8"	Bushing inserts for WE12X81	Door Handle Almond Plastic Door Handle 7 1/4" X 1 1/2"
General Electric			
WE01X10023 DE902M	WE01X10122 DE905	WE01X10152 DE410	WE01X10156 LP217
			
Metal & Plastic DE902			
			
Plastic Latch & Catch Kit	Metal Panel Clip	Idler Arm assembly Reference: WE01X10030 WE01X10032, WE01X10052	Selector Switch Knob Reference: WE01X10033
General Electric			
WE3X37 DE726R	WE3X70 DE727	WE3X75 DE726	WE3X79 DE686
			
Straight Style Bearing for WE25X205	Tub Bushing for WE13X10011 & WE25X10001 Reference: WE03X10002	Right Side Top Hat Style Bearing for WE25X205	Drum Roller Shaft Used with WE3X82 Drum Roller



Part numbers and illustrations are intended solely for identification. Items offered for sale are not represented to be manufactured by the company that built the original model.

Dryer Parts



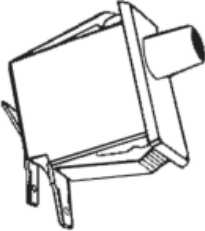
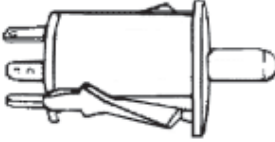

General Electric

<p>WE3X82 DE702</p>	<p>WE3X86 DE685</p>	<p>WE3X87 DE776</p>	<p>WE03X10001 DE790</p>
			
<p>Drum Roller Kit For Washer / Dryer Combo</p>	<p>Left Side Drum Roller Shaft Used with WE3X82 Drum Roller</p>	<p>Teflon Front Glide 2 3/4" X 1/2"</p>	<p>Top Felt with Glides</p>

General Electric

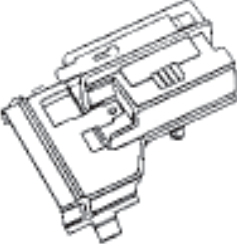
<p>WE03X1008 KIT</p> <p>For Left Side Order WE3X82 & WE3X86</p>	<p>WE4M126 ES16806</p>	<p>WE4X197 ES16700</p>	<p>WE4X444 SDE350</p>
			
<p>For Right Side Order WE3X82 & WE3X79</p>	<p>Door Switch</p>	<p>Door Switch</p>	<p>Round Igniter or Glow Bar</p>





General Electric

<p>WE4X448 DE355</p>	<p>WE4X532 ES15253</p>	<p>WE4X739 SDE358</p>	<p>WE4X750 SDE364</p>
			
<p>Infrared Flame Sensor</p>	<p>Belt Safety Switch</p>	<p>Shock Mount Round Igniter</p>	<p>"M" Style Flat Igniter Reference: WE4X843</p>

Part numbers and illustrations are intended solely for identification. Items offered for sale are not represented to be manufactured by the company that built the original model.

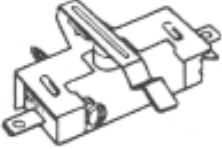
Dryer Parts

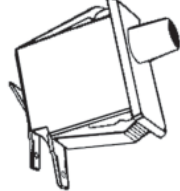



General Electric

WE4X814 LP210	WE04X10021 DE353	WE04X10046 ES16806	WE04X10132 SDE358
			
Door Switch Assembly For WE4X815 order Lever only LP985	Infrared Flame Sensor	Door Switch Reference: WE04X10034	Round Igniter Reference: WE04X10128 WE04X10116

General Electric

WE11M21C DE334	WE11X203 DE333	WE11X260 DE315D	WE11X261 DE316D
			
Restring Kit 5000 Watt 240 Volts 1/4" Q.C. Terminals	Restring Kit 5300 Watt 240 Volts 1/4" Q.C. Terminals	2 Coil Restring Kit 5000 Watt 230 Volts 1/4-28 Stud	2 Coil Restring Kit 5000 Watt 250 Volts 1/4-28 Stud

General Electric

WE11X60 DE315	WE11X61 DE316	WE11X90 DE337	WE11X99 DE338
			
1 Coil Restring Kit 2500 Watt 230 Volts 1/4-28 Stud	1 Coil Restring Kit 2500 Watt 250 Volts 1/4-28 Stud	Restring Kit 5000 Watt 230 Volts 1/4" Q.C. Terminals	Restring Kit 4500 Watt 240 Volts 5/16" Q.C. Terminals

Part numbers and illustrations are intended solely for identification. Items offered for sale are not represented to be manufactured by the company that built the original model.